

Introduction to Post-Frame Buildings

Contents

- 1.1 General 1–1
- 1.2 ANSI/ASABE S618 Definitions 1–1
- 1.3 General Building Terminology 1–13
- 1.4 History 1–16
- 1.5 Advantages 1–21
- 1.6 Ideal Structural Applications 1–23
- 1.7 References 1–34
- 1.8 Acknowledgements 1–35

1.1 General

1.1.1 Building Systems

A post-frame building system is one of many types of framing/support systems. In general, a framing/support system is concrete-based, steel-based, wood-based, or a combination of these three. Even though they may contain structural steel or concrete components, post-frame building systems fall under the broad category of wood-based framing systems. From a structural framing perspective, a post-frame building system is analogous to the typical low-rise metal building system. Conventional buildings of both types have two-dimensional primary frames that are connected with secondary framing members, and nomenclature for both building systems is similar. The major difference is that the majority of framing members in a post-frame building are wood-based, and the majority of framing members in a low-rise steel framing building system are steel.

1.1.2 Use

Post-frame buildings are well-suited for many commercial, industrial, agricultural and residential applications. Post-frame buildings offer unique advantages in terms of design and construction flexibility and structural efficiency.

1.2 ANSI/ASABE S618 Definitions

Definitions for post-frame building systems and components are contained in ANSI/ASABE S618 *Post-Frame Building System Nomenclature*. This standard was written to establish uniformity of terminology used in building design, construction, marketing and regulation. All definitions appearing in ANSI/ASABE S618 are repeated here as an introduction to this unique building system.

1.2.1 Building Systems

Post-Frame Building System: A building characterized by primary structural frames of wood posts as columns and trusses or rafters as roof framing. Roof framing is attached to the posts, either directly or indirectly through girders. Posts are embedded in the soil and supported on isolated footings, or are attached to

the top of piers, concrete or masonry walls, or slabs-on-grade. Secondary framing members, purlins in the roof and girts in the walls, are attached to the primary framing members to provide lateral support and to transfer sheathing loads, both in-plane and out-of-plane, to the posts and roof framing. See figures 1-1 to 1-3.

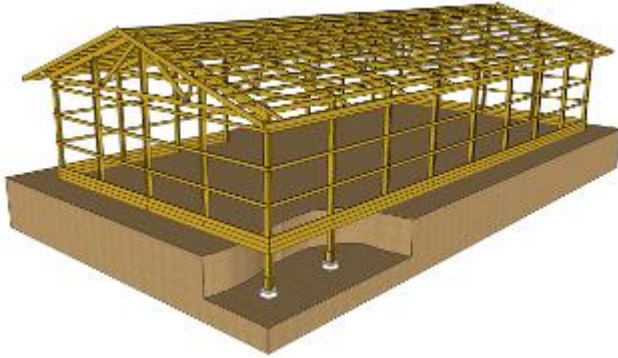

Figure 1-1. Post-frame building with trusses supported directly by embedded posts.

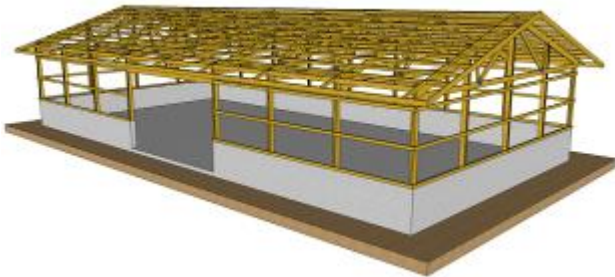

Figure 1-2. Post-frame building mounted on a concrete stem wall.

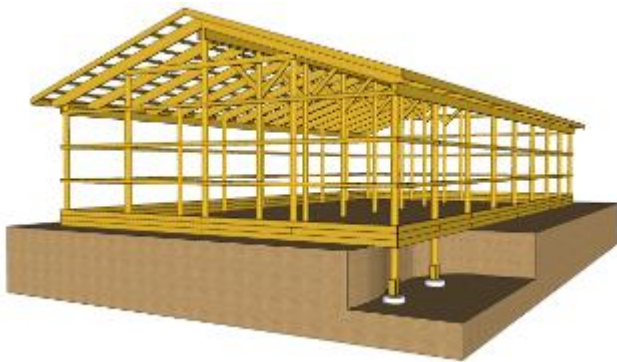

Figure 1-3. Post-frame building featuring girder supported rafters. Since all posts are round poles, this post-frame building could also be identified as a pole building.

Pole-Frame Building System: A post-frame building in which all posts are round poles. Commonly referred to as a *pole building*. See figure 1-3.

1.2.2 Building Subsystems

Primary Frame: The two-dimensional interior frame that is formed by the direct attachment of a roof truss/rafter to its respective posts. Also known as a *post-frame* or a *main frame*. See figures 1-4 to 1-9.

- **Single-Span Primary Frame:** Primary frame without any interior supports. Also known as a clear span primary frame. See figure 1-4.
- **Multi-Span Primary Frame:** Primary frame with one or more interior supports. See figures 1-5 to 1-9.
- **Solid-Web Primary Frame:** Primary frame assembled without using any open-web trusses. See figures 1-6 and 1-8.
- **Open-Web Primary Frame:** Primary frame fabricated with open-web trusses and no solid-web members for roof support. See figures 1-4, 1-5 and 1-7.
- **Hybrid Primary Frame:** Primary frame assembled with both open-web trusses and solid-web members for roof support. See figure 1-9.

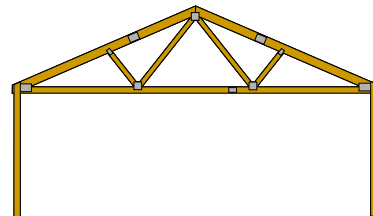

Figure 1-4. A single-span, open-web primary frame.

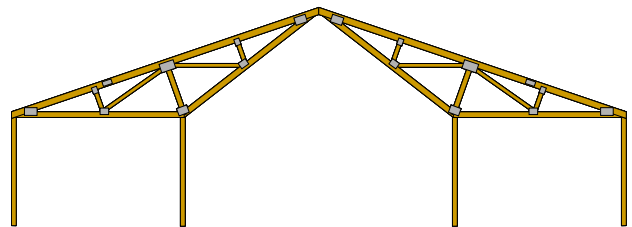

Figure 1-5. A three-span, open-web primary frame featuring twin inverted trusses.

Chapter 1 – Introduction to Post-Frame Buildings

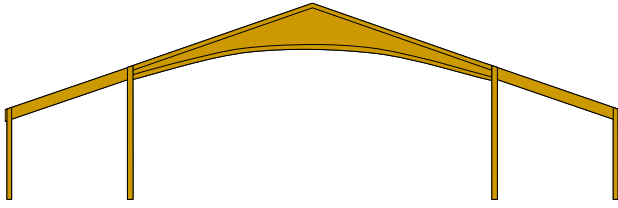

Figure 1-6. A three-span, solid-web primary frame.

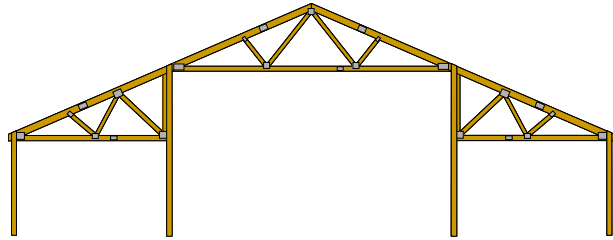

Figure 1-7. A three-span, open-web primary frame featuring a raised center bay.

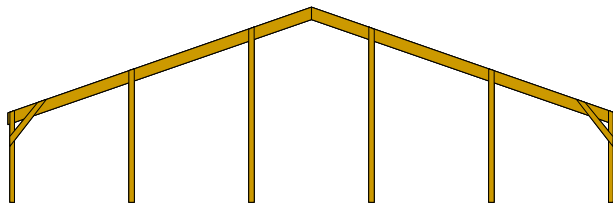

Figure 1-8. A five-span, solid-web primary frame utilizing knee-braces on the sidewall posts. (Knee braces per design requirements, not mandatory.)

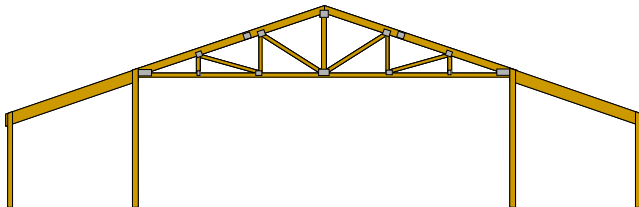

Figure 1-9. A three-span, hybrid primary frame.

Sidewall: An exterior wall oriented perpendicular to individual primary frames.

Endwall: An exterior wall oriented parallel to individual primary frames.

- **Endwall Frame:** Consists of endwall posts and the attached endwall truss or rake rafters.
- **Expandable Endwall:** Endwall frame designed with the load-bearing capability of an interior frame (i.e. primary frame) so it can serve as an interior frame when the building is expanded. See figures 1-1 to 1-3.

Diaphragm: A structural assembly comprised of structural sheathing (e.g., plywood, metal cladding) that is fastened to roof, ceiling, floor or floor framing in such a manner that the entire assembly is capable of transferring in-plane shear forces.

- **Shearwall:** A vertical diaphragm. Any endwall, sidewall, intermediate wall or portion thereof that is capable of transferring in-plane shear forces.

1.2.3 Primary Framing Members

Primary framing members are the main structural framing members in a building. In a post-frame building they include the posts, roof trusses/rafters, and any girders that transfer load between roof trusses/rafters and posts.

Post: A structural wood column. It functions as a major foundation element when it is embedded in the soil. Post-frame building posts include solid-sawn posts, structural composite lumber posts, glulam posts, mechanically-laminated lumber posts, and poles.

- **Solid-Sawn Post:** Post comprised of a single piece of sawn lumber.
- **Structural Composite Lumber Post (SCL Post):** Post comprised of a single piece of structural composite lumber. Structural composite lumber (SCL) includes, but is not limited to: parallel strand lumber (PSL), laminated veneer lumber (LVL), and laminated strand lumber (LSL).
- **Glued-Laminated Post (or Glulam Post):** Post consisting of suitably selected sawn lumber laminations joined with a structural adhesive.
- **Mechanically-Laminated Post (or Mechlam Post):** Post consisting of suitably selected sawn lumber laminations or structural composite lumber (SCL) laminations joined with nails, screws, bolts, and/or other mechanical fasteners.
 - **Nail-Laminated Post (or Nail-Lam Post):** A mechanically laminated post in which only nails have been used to join individual wood layers.
 - **Screw-Laminated Post (or Screw-Lam Post):** A mechanically laminated post in which only screws have been used to join individual wood layers.
 - **Spliced Post:** A mechanically laminated post in which individual laminations are fabricated by end-joining shorter wood members. End joints are generally unreinforced butt joints, mechanically-reinforced butt joints, glued scarf joints, or glued finger joints.
 - **Unspliced Post:** A mechanically laminated post in which individual laminations do not contain end joints.

- **Pole:** A round, naturally tapered, unsawn, wood post. Poles are sometimes slabbed to aid in fastening framing members.
- **Endwall Post:** Post located in an endwall.
- **Sidewall Post:** Post located in a sidewall.
- **Corner Post:** Post that is part of both a sidewall and an endwall.
- **Jamb Post:** Post that frames the side of a door, window, or other framed opening.

Truss: A structural framework, generally two-dimensional (i.e. planar), whose members are almost always assembled to form a series of inter-connected triangles. Perimeter members of the assembly are called truss chords and interior members are called truss webs.

- **Light Wood Truss:** A truss manufactured from wood members whose narrowest dimension is less than 5 nominal inches. Wood members include solid-sawn lumber, structural composite lumber, and glulams. Members may be connected with metal connector plates (MCP), bolts, timber connectors, and screwed- or nailed-on plywood gusset plates.

- **Metal Plate Connected Wood Truss (MPCWT):** A truss composed of wood members joined with metal connector plates (also know as truss plates). Metal connector plates (MCP) are light-gage, toothed steel plates. The most common type of light wood truss.

- **Heavy Timber Truss:** A truss manufactured from wood members whose narrowest dimension is equal to or greater than 5 nominal inches. Wood members include solid-sawn timber, structural composite lumber, and glulams. Members are generally connected with steel gusset plates that are bolted in place.
- **Ganged Wood Truss:** A truss designed to be installed as an assembly of two or more individual light wood trusses fastened together to act as one.
- **Girder Truss:** Truss designed to carry heavy loads from other structural members framing into it. Frequently a ganged wood truss.
- **Parallel Chord Truss:** Truss with top and bottom chords with equal slopes
- **Roof Truss:** A truss that directly supports a roof.

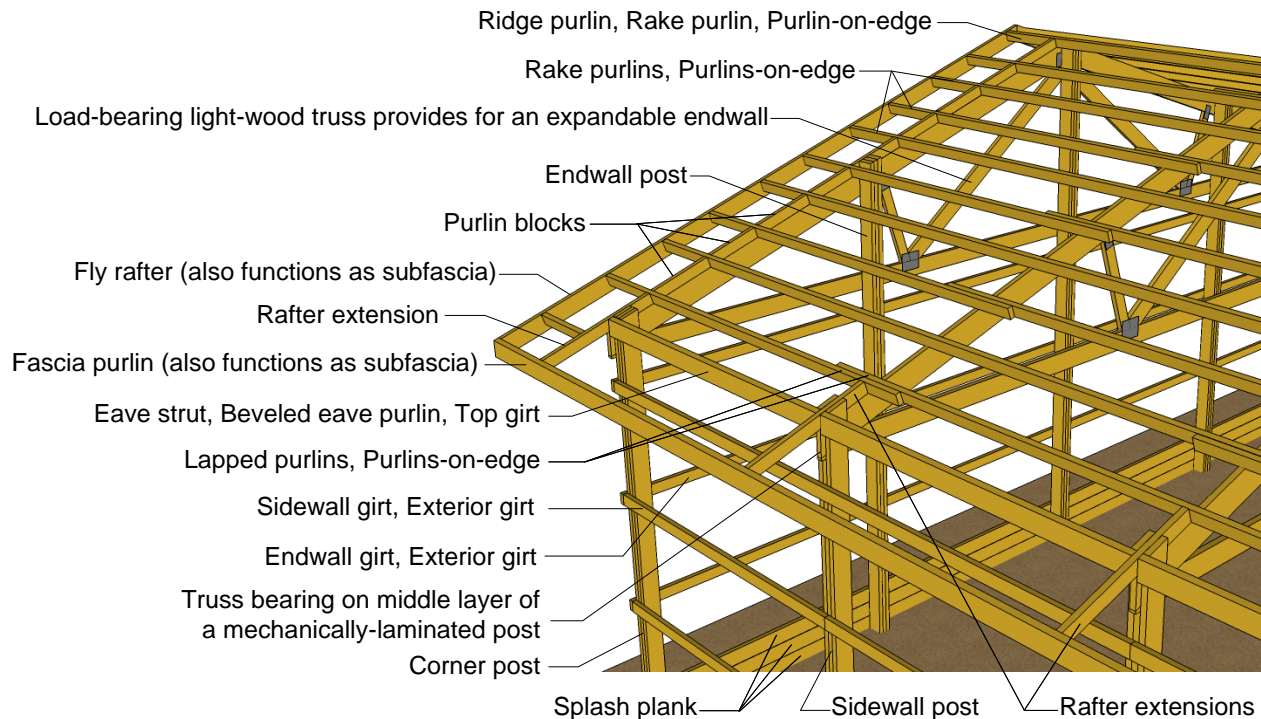

Figure 1-10. Typical corner framing.

Chapter 1 – Introduction to Post-Frame Buildings

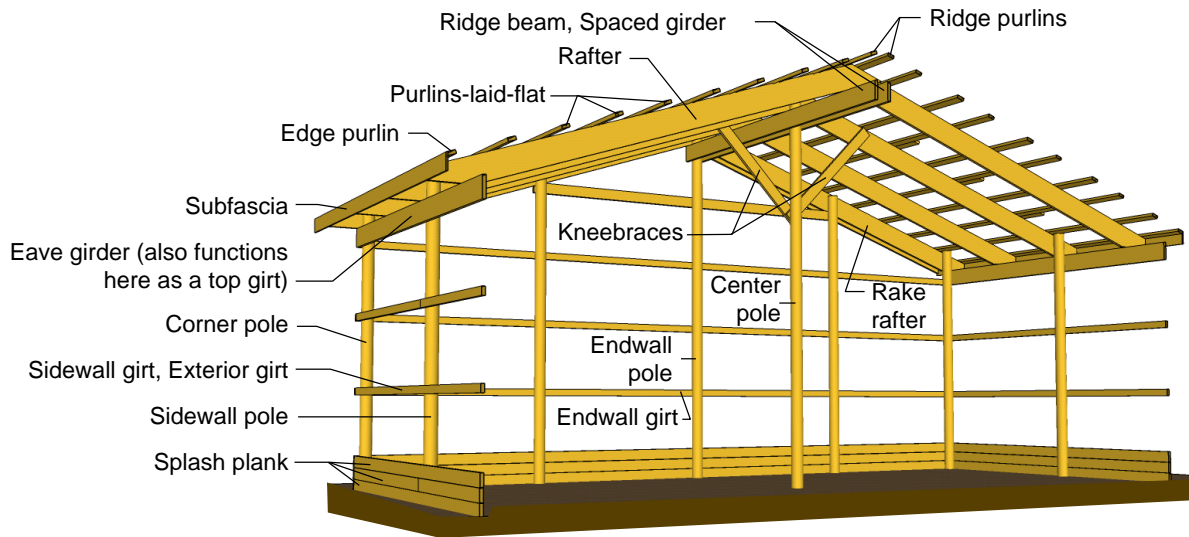

Figure 1-11. Section of a post-frame building featuring girder-supported rafters. Although posts of any type can be used to support girders, this image shows round poles being used as structural wood columns.

Rafter: One of a series of sloped, structural beams that support a roof.

- **Rake Rafter:** A rafter located in an end wall. See figure 1-11.
- **Fly Rafter:** Rafter at the rake overhang that is supported out from the endwall by rake purlins. See figure 1-10.
- **Stacked Rafter:** A narrow, deep rafter made by placing one rafter on top of another and fastening them together. Generally made by fastening dimension lumber together with metal connector plates.

Girder: A large, generally horizontal, beam. Commonly used in post-frame buildings to support trusses whose bearing points do not coincide with a post. Frequently function as headers over large door and window openings.

- **Eave Girder:** Girder located at the eave of a building. See figure 1-11.
- **Ridge Beam:** Girder located at the ridge of a building. See figure 1-11.
- **Truss Girder:** A truss that functions as a girder. Top and bottom chords of a truss girder are generally parallel.

- **Spaced Girder:** A girder composed of two beams that are separated a fixed distance by special spacers and/or the girder supports. See figures 1-11 and 1-12.

Header: Framing member at the top of a window, door or other framed opening. In general, any framing member that ties together the ends of adjacent framing members and may or may not be load bearing. See figure 1-12.

Knee Brace: A diagonally-oriented member used to stiffen and strengthen the connection between a post and the attached roof truss/rafter, or between a post and an attached girder. See figures 1-8 and 1-11.

Bearing Block: A relatively short structural support used to transfer vertical load from one structural member to another. Frequently used to transfer load from a girder to a post or a truss to a post.

Rafter Extension: A framing member attached to the end of a truss or rafter that extends the effective slope length of the roof by supporting additional purlins and/or subfascia. Rafter extensions are commonly used to help form eave overhangs as well as over shot roofs. See figures 1-10, 1-13, 1-14 and 1-15.

Tie-Down Block: A framing member used to attach a roof truss/rafter to a girder. See figure 1-12.

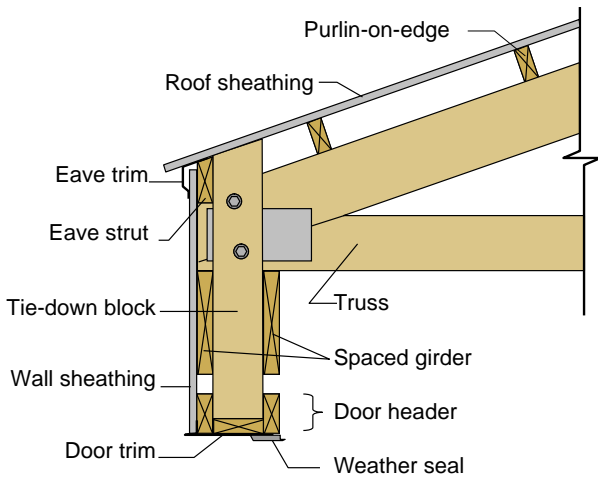

Figure 1-12. Cross-sectional view through an overhead door in the sidewall of a building without an eave overhang.

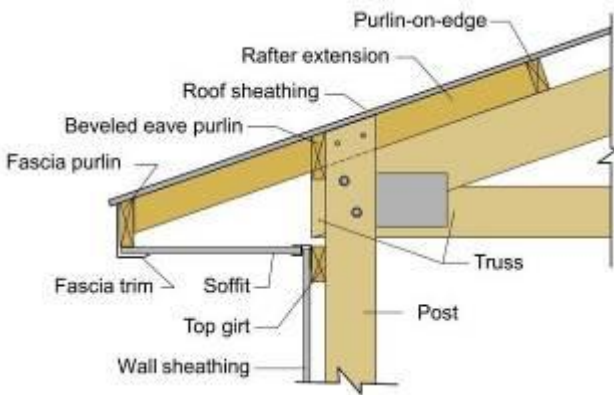

Figure 1-13. Cross-sectional view through an eave overhang that is supported by a rafter extension that runs continuously from the edge purlin/sub-fascia to the first purlin above the post. The rafter extension is fastened to the post, purlin, and top of the truss.

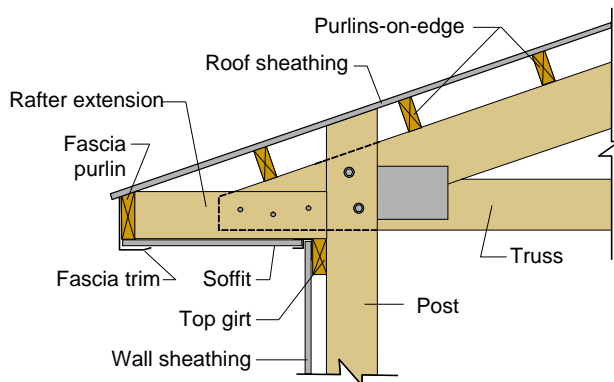

Figure 1-14. Cross-sectional view through an eave overhang that is supported by rafter extensions (one on each side of the truss) that are attached to the tail end of the truss.

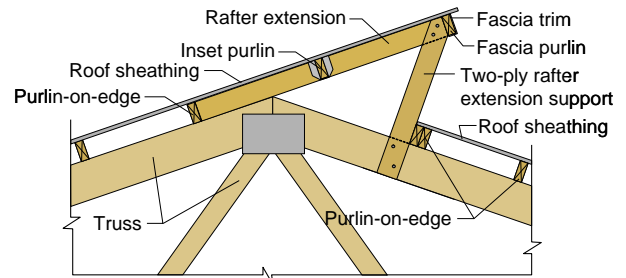

Figure 1-15. Overshot ridge with rafter extension supported by a two-ply rafter extension support. One ply is located between the rafter extension and truss top chord; the second ply extends along the sides of the rafter extension and truss chord.

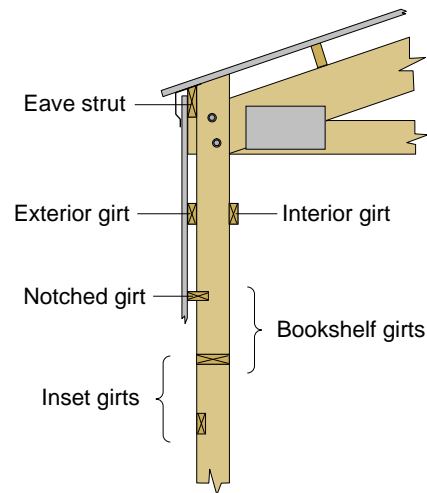

Figure 1-16. Girt types.

1.2.4 Secondary Framing Members

Secondary framing members are structural framing members used to transfer load between exterior sheathing and primary framing members, and/or to laterally brace primary framing members. Secondary framing members in a post-frame building include girts, purlins, eave struts and any structural wood bracing.

Girt: A member attached (typically at a right angle) to posts. Girts laterally support posts and transfer loads between any attached wall sheathing and the posts. See figure 1-16.

- **Exterior Girt:** A girt located entirely on the outside of posts. Also known as an outset girt. See figure 1-16.
- **Inset Girt:** A girt located entirely between adjacent posts. Frequently used to support both exterior and interior wall sheathing and horizontally-placed batt insulation. See figure 1-16.

Chapter 1 – Introduction to Post-Frame Buildings

- **Interior Girt:** A girt located entirely on the inside of posts. Generally used to support interior wall sheathing in buildings with exterior girts. See figure 1-16.
- **Notched Girt:** A girt that is notched to facilitate attachment to a post. Notching places a portion of the girt between adjacent posts, with the remainder located outside or inside the posts. See figure 1-16.
- **Bottom Girt:** The lowest girt. This could be a regular girt, grade girt, or a splash plank. See figures 1-24 and 1-25.
 - **Grade Girt:** A bottom girt located at grade. May also function as a splash plank. See figures 1-22 and 1-24.
- **Splash Plank:** Any decay and corrosion resistant girt that is in soil contact or located near the soil surface, that remains visible from the building exterior upon building completion, and is 2 to 4 inches in nominal thickness. Frequently, multiple rows of tongue and groove (T&G) splash plank are used along the base of a wall. See figures 1-10, 1-11 and 1-24.
- **Top Girt:** The highest girt. A top girt to which both roof and wall sheathing are attached is known as an eave strut. See figures 1-10, 1-11, 1-13 and 1-14.
- **Bookshelf Girt:** A girt with its wide faces horizontally oriented thus enabling it to effectively function as a shelf when left exposed. See figure 1-16.

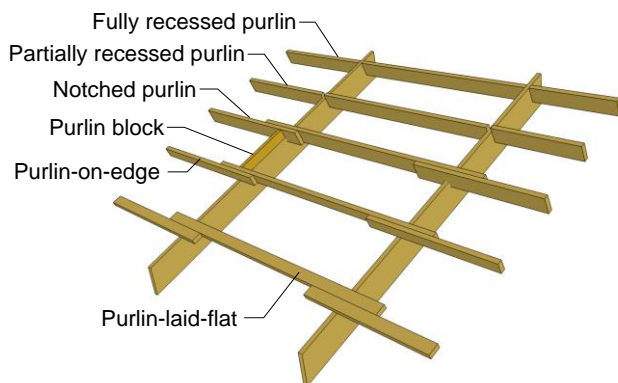

Figure 1-17. Purlin types.

Purlin: A member attached (typically at a right angle) to roof trusses/rafters. Purlins laterally support trusses/rafters and transfer load between roof sheathing and roof trusses/rafters. See figures 1-10, 1-11 and 1-17.

- **Purlin-on-Edge:** A purlin that rests on top of roof trusses/rafters with its narrow face in contact with the trusses/rafters. See figures 1-10 and 1-17.

- **Purlin-Laid-Flat:** A purlin that rests on top of roof trusses/rafters with its wide face in contact with the trusses/rafters. See figures 1-11 and 1-17.
- **Recessed Purlin:** A purlin located entirely between adjacent trusses/rafters. Single-span components that are typically held in place with special metal hangers. Also known as an inset purlin or dropped purlin. See figure 1-17.
 - **Fully Recessed Purlin:** Recessed purlin whose top edge aligns with or is below the top edge of the trusses/rafters to which it is connected. See figure 1-17.
 - **Partially Recessed Purlin:** Recessed purlin whose top edge is above the top edge of the trusses/rafters to which it is connected. See figure 1-17.
- **Notched Purlin:** A purlin that is notched to fit over roof trusses/rafters. See figure 1-17.
- **Lapped Purlins:** Two non-recessed purlins (i.e., purlins-on-edge, purlins-laid-flat, or notched purlins) that bypass each other where they are connected to the same truss/rafter. See figures 1-10 and 1-17.
- **Rake Purlin:** A purlin that overhangs the endwall of a building. See figure 1-10.
- **Ridge Purlin:** A purlin adjacent to the building ridge. See figures 1-10 and 1-11.
- **Eave Purlin:** A purlin located at the eave line of a building. An eave purlin to which both wall and roof sheathing are attached is known as an eave strut. See figure 1-13.
- **Fascia Purlin:** A purlin that helps form the fascia of a building. Also known as an edge purlin. See figures 1-13 and 1-14.
- **Edge Purlin:** A purlin in the most outer row of purlins. All fascia purlins are edge purlins but not all edge purlins are fascia purlins. The edge purlins shown in figure 1-11 are not fascia purlins as they do not help form the fascia of the building.
- **Beveled Purlin:** A purlin with an edge that has been cut at an angle, generally to facilitate cladding attachment. See figures 1-12, 1-13 and 1-14.

Eave strut: An eave purlin to which both wall and roof sheathing are attached or a top girt to which both wall and roof sheathing are attached. Simultaneous attachment of an eave strut to both wall and roof sheathing generally provides the strut with effective continuous lateral support to resist bending about both primary axes. See figures 1-12 and 1-16.

Base Plate: A corrosion and decay resistant member that is attached to the top of a concrete floor or wall. A base plate is generally located between posts and may function like a bottom girt. Unlike a girt, primary attachment of a base plate is to the concrete and not the posts. See figures 1-21 and 1-25.

Sill Plate: A corrosion and decay resistant member that is attached to the top of a concrete foundation wall, and upon which posts are attached.

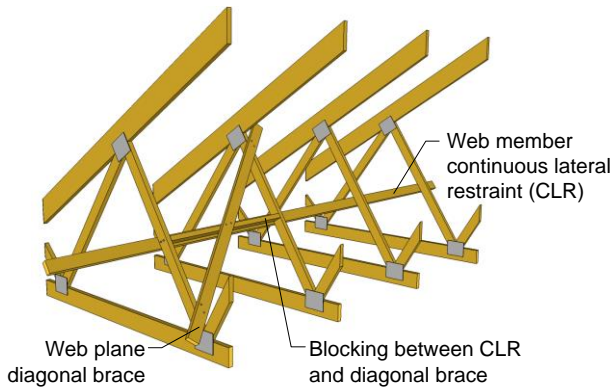

Figure 1-18. Components of a continuous lateral restraint system for web members. For larger truss spacing, individual web member reinforcement may be more economical for lateral bracing of webs than a continuous lateral restraint system.

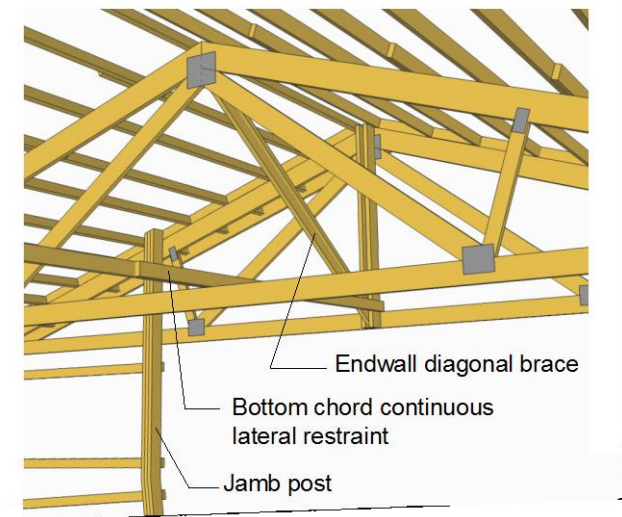

Figure 1-19. Endwall diagonal brace used to transfer endwall forces into roof diaphragm and to keep bottom chord continuous lateral restraint from shifting.

Bracing: Axially-loaded structural members used to help stabilize other structural components. The definitions in this section pertain to permanent bracing. Additional temporary bracing is generally required during construction

- **Continuous Lateral Restraint (CLR):** An uninterrupted row of structural framing members connecting a series of trusses. The row is perpendicular to truss members and thus provides lateral support to the truss members it connects. See figures 1-18 and 1-19.
 - **Bottom Chord Continuous Lateral Restraint:** A row of structural framing members that provides lateral support to the bottom chords of adjacent trusses. See figure 1-19.
 - **Web Member Continuous Lateral Restraint:** A row of structural framing members that provides lateral support to the web members of adjacent trusses. See figure 1-18.
- **Diagonal Brace.** A framing member that runs at an angle to other framing members, and with other framing members generally forms a structurally-stable triangular assembly.
 - **Web plane diagonal brace:** A diagonal brace that lies in the plane formed by the web members of adjacent trusses. The brace generally runs from the roof plane to the ceiling plane, and is required in truss web planes that contain continuous lateral restraints to keep the CLR from shifting. See figure 1-18.
 - **Bottom chord diagonal brace:** A diagonal brace that lies in the plane formed by the bottom chords of adjacent trusses (a.k.a., the ceiling plane). The braces are used to prevent bottom chord continuous lateral restraints from shifting.
 - **X-brace:** A pair of diagonal braces that cross each other thus forming an “X”. Generally, one brace will be in axial tension while the other brace is loaded in axial compression.
 - **V-brace:** A pair of diagonal braces that meet at one of their ends, thus forming a “V”. Generally, one brace will be in axial tension while the other brace is loaded in axial compression.
 - **Endwall diagonal brace:** A framing member used to transfer load from an endwall to the roof plane. Generally used above large endwall openings or where an endwall post is not continuous from grade to the rake (e.g., an endpost is terminated near the bottom chord of an endwall truss). See figure 1-19.

Chapter 1 – Introduction to Post-Frame Buildings

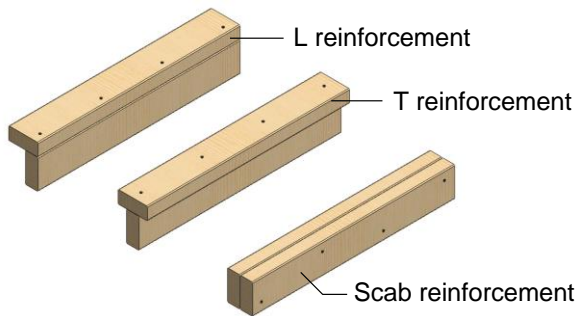

Figure 1-20. Types of individual member reinforcement.

Bracing for Individual Members. The buckling resistance of an individual framing member is often increased by attaching a T-, L-, or scab reinforcement to the side of the member. See figure 1-20.

- **T-Reinforcement:** A member that is attached to a structural framing member such that the cross-section of the two adjoined members forms a tee. See figure 1-20.
- **L-Reinforcement:** A member that is attached to a structural framing member such that the cross-section of the two adjoined members forms an el. See figure 1-20.
- **Scab Reinforcement:** A member whose wide face is attached to the wide face of a structural framing member. See figure 1-20.

Compression-Edge Brace: A brace used to provide lateral support to the compressive edge of a beam or column. More commonly referred to as a flange brace when used to support the compressive edge of an I-shaped section.

Purlin Block: A member placed between purlins to help transfer load from roof sheathing to roof framing, to reduce purlin roll, and/or to eliminate bird perch points. See figures 1-10 and 1-17.

Sub-Fascia: A structural member located under the fascia or eave/fascia trim. In a building with overhangs, the edge purlins and fly rafters generally function as subfascia. In a building without overhangs, the eave strut and rake rafters generally function as sub-fascia. See figures 1-10 and 1-11.

Lookout: A short member in an eave overhang that connects the sub-fascia and wall. Generally used to support soffit. Unlike a rafter extension, a lookout is not used to structurally support purlins or eave sub-fascia.

Track Board: A member to which a sliding door track is directly attached.

Track Board Support: A structural framing member that is used to support a track board.

1.2.5 Diaphragm Components

When post-frame building components (e.g., purlins, girts, purlin blocks, mechanical fasteners, etc.) are positioned and connected in such a way to form a diaphragm (see diaphragm definition in 1.2.2), these components take on additional names as defined in this section.

Diaphragm Structural Framing: Primary and secondary framing members to which structural sheathing panels are attached to form a diaphragm assembly.

Structural Sheathing: Frame coverings that are selected in part for their ability to absorb and transfer structural loads. Common structural sheathings include plywood, oriented strand board, and corrugated (a.k.a. ribbed) steel.

- **Structural Sheathing Panel:** An individual piece of structural sheathing.

Edge Fastener: A sheathing-to-framing connector that is located along the sides or ends of a structural sheathing panel.

Field Fastener: A sheathing-to-framing connector that is not located along the sides or ends of a structural sheathing panel.

Seam (or Stitch) Fastener: An edge fastener that connects two structural sheathing panels thereby adding in-plane shear continuity between the panels.

- **Anchored Seam Fastener:** A seam fastener that penetrates the underlying structural framing a sufficient amount so as to significantly affect the shear characteristics of the connection.

Shear Blocks: Short framing members used to help transfer shear force into or out of the structural sheathing of a diaphragm. For roof diaphragms, properly connected purlin blocks function as shear blocks.

Diaphragm Chords: Diaphragm structural framing members that run perpendicular to the applied load, and thus are subjected to axial forces when the load works to bend the diaphragm.

Drag Strut: A member, typically horizontal, that transfers shear from a floor, roof or ceiling diaphragm to a shear wall.

Structural Ridge Cap: A component that covers the ridge of a building and is capable of transferring shear force between diaphragms located on opposite sides of the ridge.

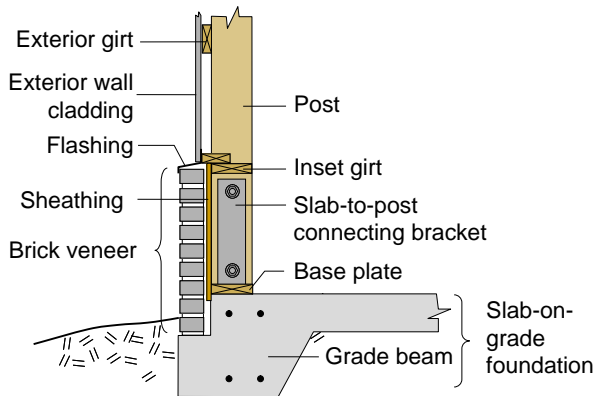

Figure 1-21. Slab-on-grade foundation.

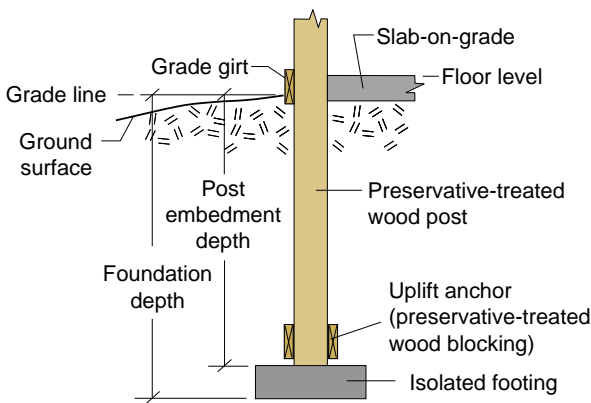

Figure 1-22. Post foundation featuring a preservative-treated wood blocks for uplift anchorage.

1.2.6 Foundation Components

This section contains descriptions of foundation components that are used to define foundation types in Section 1.2.7.

Embedded Pier: A relatively short column embedded in the soil to provide support for an above-grade post, beam, wall, or other structure. Piers include members of any material with assigned structural properties such as solid or laminated wood, steel, or concrete. Embedded piers differ from embedded posts in that they seldom extend above the lowest horizontal framing element in a structure, and when they do, it is often not more than a foot. See figure 1-24.

Footing: Foundation component at the base of a post, pier or wall that provides resistance to vertical downward forces. When a footing is located below grade and properly attached to a post, pier or wall, it aids in the resistance of lateral and vertical uplift forces. See figures 1-22 to 1-25.

Uplift Anchor: Any element mechanically attached to an embedded post or pier to increase the uplift resistance of the foundation. Common uplift anchors include concrete footings, concrete collars, preservative-treated wood blocks, steel angles, and concrete backfill. See figures 1-22 to 1-24.

Collar: Foundation component attached below grade to an embedded post or pier, and that moves with it to resist lateral and vertical loads. See figure 1-23.

Grade Beam: A corrosion and decay resistant beam located on the soil surface. Also a long, thickened, and more heavily-reinforced portion of a slab-on-grade foundation. See figure 1-21.

1.2.7 Foundations Types

This section defines foundation types that are commonly used to support post-frame building systems.

Post Foundation: A foundation consisting of an embedded post and all attached below-grade elements, which may include a footing, uplift resistance system, and collar. See figures 1-22 and 1-23.

Pier Foundation: A foundation consisting of an embedded pier and all attached below-grade elements, which may include a footing, uplift resistance system, and collar. See figure 1-24.

- **Pier and Beam Foundation:** A pier foundation that supports a grade beam.

Slab-On-Grade Foundation: A reinforced concrete slab that rests on the soil surface. Slab areas located directly beneath structural columns or walls are generally thicker and more heavily reinforced. Long, thickened and reinforced portions are generally referred to as grade beams. See figure 1-21.

Stem Wall Foundation: A foundation consisting of a continuous wall that may be placed on a continuous footing. The base of the foundation is generally located below expected frost penetration depths. See figure 1-25.

Chapter 1 – Introduction to Post-Frame Buildings

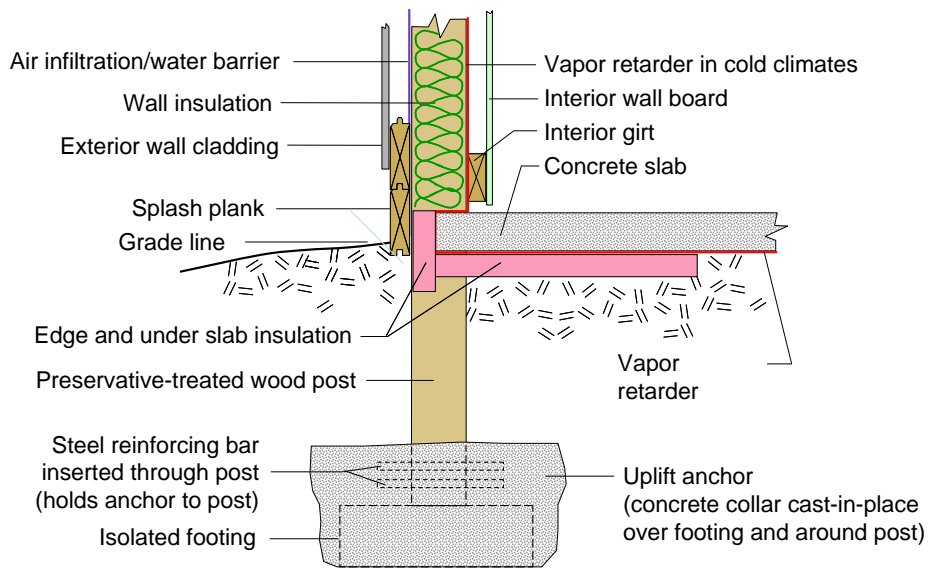

Figure 1-23. Post foundation featuring a cast-in-place concrete collar for uplift anchorage and increased lateral resistance. Concrete collar need not surround footing (as shown above) to be effective in resisting uplift.

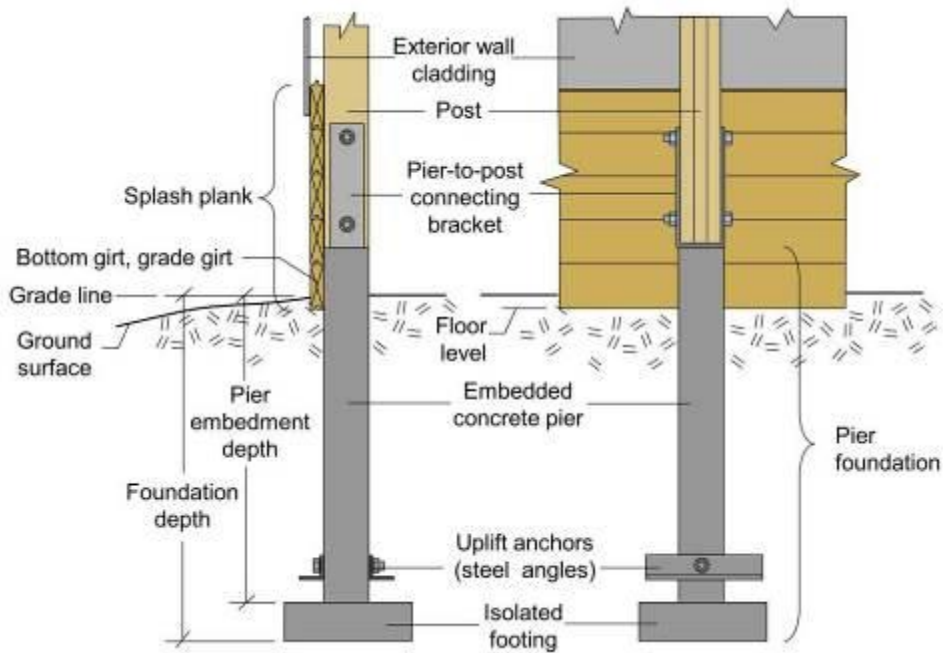

Figure 1-24. Pier foundation featuring steel angles for uplift anchorage.

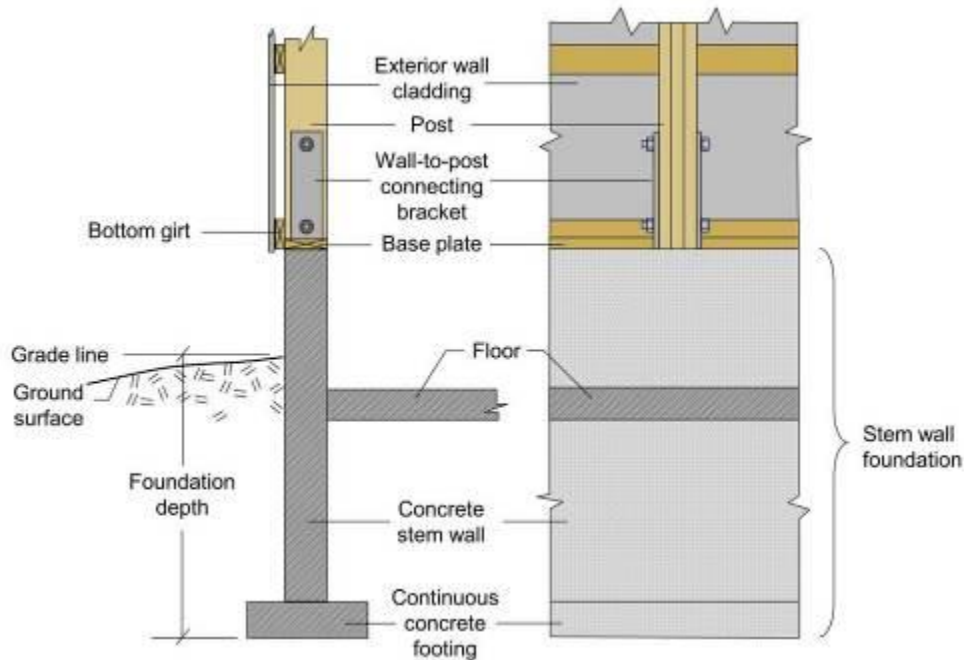

Figure 1-25. Stem wall foundation.

1.2.8 Dimensions

Grade Line (Grade Level): The line of intersection between the building exterior and the finished ground surface and/or top of the pavement in contact with the building exterior. See figures 1-22 to 1-25.

Floor Level: Elevation of the finished floor surface. In the absence of a finished floor, the floor level is taken as the elevation of the bottom edge of the bottom girt. In buildings with stemwall foundations and no finished floor, floor level is taken as the elevation of the unfinished floor. See figure 1-22.

Eave Line: Line formed by the intersection of the plane formed by the top edge of the purlins and the plane formed by the outside edge of the sidewall girts.

Rake Line: Line formed by the intersection of the plane formed by the top edge of the purlins and the plane formed by the outside edge of the endwall girts.

Ridge Line: Line formed by the intersection of the plane formed by the top edge of the purlins on one side of the roof and the plane formed by the top edge of the purlins on the opposite side of the roof. For a mono-slope roof, the ridge line is the line formed by the intersection of the plane formed by the top edge of the purlins and the plane formed by the outside edge of the girt in the tallest sidewall.

Foundation Depth: Vertical distance from the grade line to the bottom of the foundation. Typically the vertical distance from the ground surface to the base of the footing. (a.k.a., foundation embedment depth). See figures 1-22 to 1-25.

Post Embedment Depth: Vertical distance from the grade line to the bottom of an embedded post. Equal to the foundation depth when the post does not bear on a footing or other foundation element. See figure 1-22.

Pier Embedment Depth: Vertical distance from the grade line to the bottom of a pier. Equal to the foundation depth when the footing is part of the pier (i.e., the footing is cast integrally with the pier). See figure 1-24.

Clear Height: Vertical distance between the finished floor and the lowest part of a truss, rafter, or girder.

Post Height: The length of the non-embedded portion of a post.

Eave Height: Vertical distance between the floor level and the eave line.

Building Height: Vertical distance between the floor level and the ridge line. (a.k.a., ridge height).

Building Bay: The area between adjacent post-frames.

Chapter 1 – Introduction to Post-Frame Buildings

Frame Spacing: On-center horizontal spacing of primary frames. Frame spacing may vary within a building. (a.k.a., bay width).

Clear Span: Horizontal distance from the face of one support to the face of the opposite support.

Building Width: Horizontal distance between the outside face of the girts in one sidewall and the outside face of the girts in the opposite sidewall.

Building Length: Horizontal distance between the outside face of the girts in one endwall and the outside face of the girts in the opposite endwall.

Eave Overhang Distance: Horizontal distance from the eave line to the outside of the subfacia.

Rake Overhang Distance: Horizontal distance from the rake line to the outside of the fly rafter.

Girt Spacing: On-center vertical spacing of girts.

Purlin Spacing: On-center spacing of purlins.

1.3 General Building Terminology

The following terms and abbreviations are not specific to post-frame buildings, and thus are defined outside of ASABE S618 *Post-Frame Building System Nomenclature*.

AF&PA: American Forest & Paper Association (formerly National Forest Products Association).

AITC: American Institute of Timber Construction.

ALSC: American Lumber Standard Committee.

ANSI: American National Standards Institute

APA: The Engineered Wood Association (formerly the American Plywood Association)

ASABE: The American Society of Agricultural and Biological Engineers.

ASCE: American Society of Civil Engineers.

ASD: Allowable Stress Design

AWC: American Wood Council. The wood products division of the American Forest & Paper Association (AF&PA).

AWPB: American Wood Preservers Bureau.

Bearing Point: The point at which a component is supported.

Board: Wood member less than two (2) nominal inches in thickness and one (1) or more nominal inches in width.

Board-Foot (BF): A measure of lumber volume based on nominal dimensions. To calculate the number of board-feet in a piece of lumber, multiply nominal width in inches by nominal thickness in inches by length in feet and divide by 12.

Butt Joint: The interface at which the ends of two members meet in a square cut joint.

Camber: A predetermined curvature designed into a structural member to offset the anticipated deflection when loads are applied.

Check: Separation of the wood that usually extends across growth rings (i.e., a split perpendicular-to-growth rings). Commonly results from stresses that build up in wood during seasoning.

Cladding: The exterior and interior coverings fastened to framing.

Components and Cladding: Elements of the building envelope that do not qualify as part of the main wind-force resisting system as defined in ASCE/SEI 7. In post-frame buildings, this generally includes individual purlins and girts, and cladding.

Diaphragm Action: The transfer of load by a diaphragm.

Diaphragm Design: Design of roof and ceiling diaphragm(s), wall diaphragms (shearwalls), primary and secondary framing members, component connections, and foundation anchorages for the purpose of transferring lateral (e.g., wind) loads to the foundation structure via diaphragm action.

Dimension Lumber: Wood members from two (2) nominal inches to but not including five (5) nominal inches in thickness, and 2 or more nominal inches in width.

Eave: The part of a roof that projects over the sidewalls. In the absence of an overhang, the eave is the line along the sidewall formed by the intersection of the wall and roof planes.

Fascia: Flat surface (or covering) located at the outer end of a roof overhang or cantilever end.

Flashing: Sheet metal or plastic components used at major breaks and/or openings in walls and roofs to insure weather-tightness in a structure.

Gable: Triangular portion of the endwall of a building directly under the sloping roof and above the eave line.

Gable Roof: Roof with one slope on each side. Each slope is of equal pitch.

Gambrel Roof: Roof with two slopes on each side. The pitch of the lower slope is greater than that of the upper slope.

Hip Roof: Roof which rises by inclined planes from all four sides of a building.

IBC: International Building Code.

ICC: International Code Council.

Laminated Strand Lumber (LSL): A structural composite lumber (SCL) assembly comprised of wood strands bonded with resins under heat and pressure. Strand fibers are primarily oriented along the length of the member. The least dimension of the strands shall not exceed 0.10 in. (2.54 mm) and the average length shall be a minimum of 150 times the least dimension.

Laminated Veneer Lumber (LVL): A structural composite lumber (SCL) assembly manufactured by gluing together wood veneer sheets. Each veneer is oriented with its wood fibers parallel to the length of the member. Individual veneer thickness does not exceed 0.25 inches.

Loads: Forces or other actions that arise on structural systems from the weight of all permanent construction, occupants and their possessions, environmental effects, differential settlement, and restrained dimensional changes.

- **Dead Loads:** Forces induced by the gravitational attraction between the earth and the mass of the building components.
- **Live Loads:** Loads resulting from the use and occupancy of a building.
- **Seismic Load:** Forces induced in a structure due to the horizontal acceleration and deceleration of the building foundation during an earthquake.
- **Snow Load:** Forces induced by the gravitation attraction between the earth and any snow that accumulates on the building.
- **Wind Loads:** Loads caused by the wind blowing from any direction.

Lumber Grade: The classification of lumber in regard to strength and utility in accordance with the grading rules of an approved (ALSC accredited) lumber grading agency.

LRFD: Load and Resistance Factor Design

LVL: see Laminated Veneer Lumber.

Main Wind-Force Resisting System: An assemblage of structural elements assigned to provide support and stability for the overall structure. Main

wind-force resisting systems in post-frame buildings include the individual post-frames, diaphragms and shearwalls.

Manufactured Component: A component that is assembled in a manufacturing facility. The wood trusses and laminated columns used in post-frame buildings are generally manufactured components.

MBMA: Metal Building Manufacturers Association.

NDS®: ANSI/AWC NDS®-2012 *ASD/LRFD National Design Specification® for Wood Construction*. American Wood Council, Leesburg, VA www.awc.org

Metal Cladding: Metal exterior and interior coverings, usually cold-formed aluminum or steel sheet, fastened to the structural framing.

NFBA: National Frame Building Association.

NFPA: National Fire Protection Association.

Nominal Size: The named size of a member, usually different than its actual size (as with lumber).

Oriented Strand Board (OSB): Structural wood panels manufactured from reconstituted, mechanically oriented wood strands bonded with resins under heat and pressure.

Oriented Strand Lumber (OSL): A structural composite lumber (SCL) assembly comprised of wood strands bonded with resins under heat and pressure. Strand fibers are primarily oriented along the length of the member. The least dimension of the strands shall not exceed 0.10 in. (2.54 mm) and the average length shall be a minimum of 75 times the least dimension.

OSB: See Oriented Strand Board.

Parallel Strand Lumber (PSL): Structural composite lumber (SCL) manufactured by cutting 1/8-1/10 inch thick wood veneers into narrow wood strands, and then gluing and pressing the strands together. Individual strands are up to 8 feet in length. Prior to pressing, strands are oriented so that they are parallel to the length of the member.

Pennyweight: A measure of nail length, abbreviated by the letter d.

Plywood: A wood panel comprised of wood veneers. The grain orientation of adjacent veneers are typically 90 degrees to each other.

Pressure Preservative Treated (PPT) Wood: Wood pressure-impregnated with an approved preservative chemical under approved treatment and quality control procedures.

PSL: See Parallel Strand Lumber.

Chapter 1 – Introduction to Post-Frame Buildings

Rake: The part of a roof that projects over the endwalls. In the absence of an overhang, the rake is the line along the endwall formed by the intersection of the wall and roof planes.

Ridge: Highest point on the roof of a building which describes a horizontal line running the length of the building.

Ring Shank Nail: See threaded nail.

Roof Overhang: Roof extension beyond the endwall/sidewall of a building.

Roof Slope: The angle that a roof surface makes with the horizontal. Usually expressed in units of vertical rise to 12 units of horizontal run.

Self-Drilling Screw: A screw fastener that combines the functions of drilling and tapping (thread forming). Generally used when one or more of the components to be fastened is metal with a thickness greater than 0.03 inches

Self-Piercing Screw: A self-tapping (thread forming) screw fastener that does not require a pre-drilled hole. Differs from a self-drilling screw in that no material is removed during screw installation. Used to connect light-gage metal, wood, gypsum wallboard and other "soft" materials.

SFPA: Southern Forest Products Association

Shake: Separation of annual growth rings in wood (splitting parallel-to-growth rings). Usually considered to have occurred in the standing tree or during felling.

SIP: Structural Insulated Panel.

Siphon Break: A small groove to arrest the capillary action of two adjacent surfaces.

Soffit: The underside covering of roof overhangs.

SPIB: Southern Pine Inspection Bureau.

Structural Composite Lumber (SCL):

Reconstituted wood products comprised of several laminations or wood strands held together with an adhesive, with fibers primarily oriented along the length of the member. Examples include LVL and PSL.

Threaded Nail: A type of nail with either annual or helical threads in the shank. Threaded nails generally are made from hardened steel and have smaller diameters than common nails of similar length.

Timber: Wood members five or more nominal inches in the least dimension.

TPI: Truss Plate Institute.

Wane: Bark, or lack of wood from any cause, on the edge or corner of a piece.

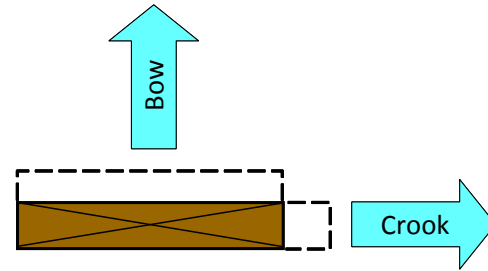

Figure 1-26. Lumber warping terminology: bow versus crook as viewed from end of wood member.

Warp: Any variation from a true plane surface. Warp includes bow, crook, cup, and twist, or any combination thereof.

- **Bow:** Deviation, in a direction perpendicular to the wide face, from a straight line drawn between the ends of a piece of lumber. See figure 1-26.
- **Crook:** Deviation, in a direction perpendicular to the narrow edge, from a straight line drawn between the ends of a piece of lumber. See figure 1-26.
- **Cup:** Deviation, in the wide face of a piece of lumber, from a straight line drawn from edge to edge of the piece.
- **Twist:** A curl or spiral of a piece of lumber along its length. Measured by laying lumber on a flat surface such that three corners contact the surface. The amount of twist is equal to the distance between the flat surface and the corner not contacting the surface.

WCLIB: West Coast Lumber Inspection Bureau

WTCA: Wood Truss Council of America.

WWPA: Western Wood Products Association.

1.3.1 Heavy Timber Construction

Post-frame buildings are frequently and incorrectly referred to as post and beam buildings or as timber frame buildings. Much of the confusion between the framing systems occurs because they are all generally designed around two-dimensional (2-D) frames. In post-frame buildings these 2-D frames are referred to as primary frames, post-frames or main frames. In post and beam buildings and timber frame buildings they are commonly referred to as bents. The key to understanding the difference between the three building systems is to focus on these 2-D frames. If the main member(s) connecting the posts within a 2-D frame fall into the timber category (timbers are defined as members larger than 5 nominal inches in the least dimension), the building would be classified as a post and beam building or a timber frame building.

According to the Timber Frame Business Council or TFBC (<http://timberframe.org/faq.html>), a timber framed building is a specialized version of post and beam building that utilizes wood joinery such as mortise and tenon, held in place with wooden pegs as shown in figure 1-27. According to this definition, it is not proper to refer to a post and beam building as a timber-frame building when timbers are connected with special metal fasteners, metal plates and other metal connectors.



Figure 1-27. Timber-frame building designed by Steven Knox and built by Connolly & Company, Edgecomb, Maine. Image from <http://stknox.com/images/StudioBarnFrame.JPG>.

1.4 History

A condensed history of the post-frame building system follows. Early history is based on an accounting provided by James T. Knight (1989) who served as executive director of the National Frame Building Association (NFBA) for nearly three decades.

1.4.1 Ancient History

The concept of pole-type structures is not new. Archeological evidence exists in abundance that pole buildings have been used for human housing for thousands of years in many areas of the world. Although ancient pole buildings have long since disappeared from the landscape, their size and original location are easily determined by the variations in soil color (i.e. soil staining) that occurs when embedded wood poles decay inside the surrounding soil.

1.4.2 Pole Buildings at Jamestown, VA

The very first buildings constructed by English settlers in North America were pole buildings constructed inside the James Fort palisade (i.e. fort wall) at Jamestown, VA. These buildings were erected within a few weeks of the settlers May 13, 1607 arrival on James Island. In an effort to duplicate methods used in construction of these buildings, the barrack's frame shown in Figures 1-28 and

1-29 was erected on the site in 2011. Appearing behind the barrack in figures 1-28 and 1-29 is a replicate section of the palisade which was constructed by embedding wood poles (i.e., pales) alongside each other.



Figure 1-28. Frame of pole building barrack erected in 2011 in an effort to duplicate construction methods used during the colonization of Jamestown. Located behind the replicate barrack is a replicate palisade.



Figure 1-29. Close-up of the barrack shown in figure 1-28. Embedded poles support a girder which in turn supports rafters. Note the similarities between this construction and that shown in figure 1-3.

The most significant of the pole buildings located in James Fort was the church erected in 1608. Although this was the second church built at the site (the first burnt down soon after construction), it is considered the first major Protestant church building in North America. It is famous for housing the wedding of Pocahontas and tobacco planter John Rolfe during the spring of 1614. The exact location of the church was discovered in 2010 by archeologists who uncovered its postholes (Kelso, 2011). Overall building size was found to exactly match the 24 x 60 foot size recorded in 1610 by William Strachey who was the secretary of the colony. Postholes

Chapter 1 – Introduction to Post-Frame Buildings

were located exactly 12-foot on center. Their locations are now permanently marked at the site with stub posts (figure 1-30).



Figure 1-30. Stub posts mark the location of the fourteen poles that supported the 1608 church located inside James Fort. A statue of Captain John Smith and the James River appear to the left.

Walls of the Jamestown pole buildings were finished by attaching vertical wood slats to girts (see figure 1-29) and then packing clay around the wood poles, girts and vertical slats. The clay surface was then waterproofed with a mixture of lime and animal fat. Roofs were thatched with marsh grass harvested from surrounding swamps.

It is clear that the English settlers used pole buildings for the same basic reasons we use post-frame buildings today – they can be quickly erected, and they make efficient use of readily-available materials.

Use of pole buildings in America continued throughout the colonization of the country. Norum (1967) reports use of pole buildings on farms in the 19th century.

1.4.3 D. Howard Doane

The modern post-frame structure can trace its roots to D. Howard Doane, founder of Doane Agricultural Service (DAS). Doane had an unwavering vision of a more efficient, productive agriculture, and he worked to improve profitability in all aspects of the farm enterprises that DAS helped manage. Doane's drive led him to explore options to the heavy timber framed buildings that were the mainstay of production agricultural. In the early 1930's, he erected buildings utilizing embedded red cedar poles as their primary supports. The poles supported girders upon which rafters were placed on two-foot centers. Purlins consisted of one-inch thick boards that were laid flat and spaced 12 to 18 inches apart. This frame was covered with corrugated galvanized steel.

1.4.4 Bernon Perkins

Bernon George Perkins was hired by DAS as a farm manager in the mid-1930s and began using creosote treated poles instead of the more scarce cedar poles. Within a relatively short period of time, preservative treated poles became the mainstay of this new building system. In a textbook titled *Farm Buildings* that was published in 1941, author John C. Wooley introduces "pole-frame" as the simplest type of barn frame. Wooley states that "in many of the newer structures using this type of frame, treated poles are being used, and a footing is provided for each pole." Contrary to this statement by Wooley, the use of footings was actually relatively rare.

Perkins is attributed with two other developments of the modern post-frame building system. He was the first to place 2- by 4-inch members on-edge as purlins, and he was the first to overlap purlins. By installing purlins-on-edge, Perkins was able to increase both rafter and purlin spacing. Overlapping of purlins led to more rapid construction and an improved purlin-to-rafter connection. In 1949, Perkins applied for a patent on a pole-frame building designed for storing and drying hay, grain and other commodities. The patent was granted in June, 1953 (Patent No. 2,641,988). Figure 1 from this patent is reproduced in figure 1-31 and shows the lapped, 2- by 4-inch on-edge purlins characteristic of Perkins' buildings.

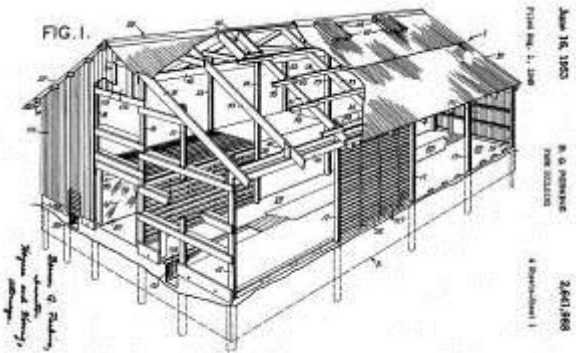

Figure 1-31. Figure 1 from U.S. Patent No. 2,641,988 granted in June, 1953.

Although DAS was the assignee on Perkins' patent, it had no interest in protecting the patent from infringement by others. In fact, D. Howard Doane had Perkins and other employees actively encourage builders and farmers to accept and utilize their ideas. Perkins began a "builders program" in the early 1950's and traveled around the country with Tom Locke, a DAS engineer, sharing plans with builders involved in and/or interested

in pole-frame building construction. The program was dissolved in 1954.

1.4.5 Truss Use

The 1950's saw increased use of trusses in farm buildings. By the late 1950's, truss use in pole-frame buildings became the rule rather than the exception. Many trusses were fabricated with the use of ½-inch thick plywood gussets held in place with glue and nails. Fabrication of such trusses was quite labor intensive because of the time required to hand drive numerous nails. Bolted trusses and trusses utilizing timber connectors were also commonly used (trusses using split ring timber connectors were generally referred to as "bolt and ring" trusses). In the early 1960's, buildings with 40-ft clearspans were commonly erected. By the early 1970's, buildings with 60-ft clearspans were routinely built.

1.4.6 Patterson Publication

In 1957 the American Wood Preservers Institute published a document written by Donald Patterson titled *Pole Building Design*. Written for use by engineers, *Pole Building Design* stressed engineering concepts that were "somewhat unusual or unique in pole-type buildings." A major portion of the document was dedicated to methods for determining the depth of embedment of poles - methods based on research funded by the Outdoor Advertising Association of America.

1.4.7 Metal Plate Connected Trusses

The 1960's ushered in the age of the metal plate connected wood truss (MPCWT). Early MPCWTs featured metal connector plates with much larger teeth and lower tooth densities than today's plates. Not until the early 70s did most post-frame building companies begin transitioning from bolted trusses to MPCWTs.

1.4.8. Rectangular Posts

The 1960's also saw the pole-frame building industry begin its transformation into the post-frame building industry as builders began to abandon poles in favor of solid-sawn posts. In some cases the transition was from buildings with round poles to buildings with all slabbed poles, and then to buildings with slabbed poles in all locations except the corners where rectangular posts were used, and finally to buildings with all rectangular posts. Although size-for-size solid-sawn posts typically lacked the bending strength of the poles they replaced, they enabled more rapid and accurate frame erection, as well as the straight-forward installation of quality interior wall finishes (something not easily accomplished with tapered poles). Finished interiors had become more common place as (1) farmers began to utilize thermally-insulated post-frame buildings for shops, offices and certain livestock housing facilities, and (2) the industry

began to carve out a niche in the commercial building market.

1.4.9 NFBA Formation

A landmark moment for the industry came in 1969 when the State of Indiana looked to adopt building code provisions requiring "continuous concrete foundations" for all "wood frame commercial buildings". Because of the negative impact this would have on post-frame building, Freemon D. Borkholder organized a meeting which was attended by approximately twenty builders. It was during this 1969 meeting that the decision was made to form an organization of post-frame builders and to call it the National Frame Builders Association (NFBA). In 2007 the word "Builders" was changed to "Building" (i.e., NFBA became the National Frame Building Association) in recognition that the organization is made up of more than just active builders (i.e., it includes suppliers, designers, researchers, etc.).

Use of the term "post frame" does not appear to have been coined during the 1969 Indiana meeting. In his 1941 *Farm Buildings* textbook, author John C. Wooley uses the term "post frame" to refer to buildings with rough, hewed, sawed, or built-up posts placed at 10- or 12-ft intervals and placed on a wood sill or directly on a concrete foundation.

1.4.10 Engineering Infusion

As they expanded into commercial building markets in the late 1960's and early 1970's, larger post-frame building companies began employing their own registered professional engineers for in-house production of all plans, specifications and structural calculations required by code for commercial buildings. This infusion of engineering into the post-frame building industry impacted more than just commercial buildings, as it brought with it the science to safely build larger agricultural structures. Although the importance of properly engineering a building has never been in dispute, few agricultural buildings were fully engineered prior to the 1970's. This is because agricultural buildings were (and still are) exempt from building codes in virtually every jurisdiction in the United States. Although more engineering has been put into agricultural buildings in the past half-century, it is important to realize that many agricultural structures are still constructed with little or no engineering input.

1.4.11 Concrete Footings

Concrete footings which were largely absent from pole-frame buildings erected prior to the 1960's, became standard elements under embedded posts in the 1970's. This can be attributed to significant increases in post bearing pressures, and to commercial building engineering that routinely showed actual soil pressures vastly exceeding allowable soil pressures when footings

Chapter 1 – Introduction to Post-Frame Buildings

were absent. Increases in post bearing pressure were directly attributable to increases in clearspan distances (i.e., axial post loads increase in direct proportion to the clearspan distance between posts in a primary frame) and to decreases in post bearing area. In many cases, the butt-end of tapered poles was often greater than the cross-sectional area of the rectangular posts that replaced them.

1.4.12 Penta and CCA Wood Treatments

In the 1940's, pentachlorophenol largely replaced creosote as the preferred preservative treatment for wood, especially for pole-frame building applications. Although creosote was a very effective treatment, the resulting oily surface made it virtually impossible to seal in its strong objectionable odors. Creosote-treated poles were also messy to handle, particularly in warm weather. By the early 1980's chromate copper arsenate (CCA) had effectively supplanted pentachlorophenol in post-frame buildings. As a waterborne preservative, CCA was easier to stain, paint and seal. CCA was also considered to be less of a hazard to humans than penta-treated wood. In fact, in 1984, the EPA banned the use of pentachlorophenol for all indoor applications, except for a few low exposure uses which included embedded poles and posts used in agricultural applications.

1.4.13 Diaphragm Design

In the mid-1980's, post-frame building engineers began discussing a procedure published in 1983 by Hoagland and Bundy for calculating the percentage of horizontal wind load transferred to shear walls by metal-clad roofs in post-frame buildings. This procedure, referred to as diaphragm design, was based on methods outlined for metal-clad steel-framed diaphragms by Bryan (1973), and featured an equation developed by Luttrell (1967) for extrapolating diaphragm test panel data for use in full-scale building design. The first research on metal-clad wood frame diaphragms can be traced to Hurst and Mason who in 1961 published results of tests on two separate (but similar) metal-clad pole buildings that showed that roof and endwall cladding contributed significantly to the overall rigidity of the structure. The first metal-clad wood-frame diaphragm test panels were tested over 15 years later by Hausmann and Esmay (1977) and White (1978).

The diaphragm design procedure published by Hoagland and Bundy in 1983 was slightly modified by Gebremedhin and others (1986), and formed the basis for ASAE EP484 *Diaphragm Design of Metal-Clad, Post-Frame Rectangular Buildings*. Work on the ASAE EP484 commenced in 1986 under the direction of Harvey Manbeck and was approved for publication in 1989 (Manbeck, 1990).

ASAE EP484 requires strength and stiffness values for all load-resisting diaphragms and shearwalls in a building. Consequently, numerous metal-clad wood-frame diaphragm panel tests have been conducted since the 1980's. Sources and a compilation of data from many of these tests are provided in Chapter 8.

A major revision to ASAE EP484 was completed in 1998. This revision included the simplified design approach outlined by Bohnhoff (1992a) and also allowed for more detailed diaphragm analyses including the Force Distribution Method developed by Anderson (1989) and computer program DAFI developed by Bohnhoff (1992).

1.4.14 Mechanically-Laminated Posts

In the early 1980's, builders began switching from solid-sawn posts to nail-laminated posts. This switch was driven by the lack of stress-rated timber, decay issues with solid-sawn posts, and a need for posts that could withstand higher bending stresses. Decay problems became more prevalent when builders switched from poles to sawn posts, primarily because of the difficulty of treating heartwood exposed by sawing operations.

In the mid-1980's, builders began utilizing spliced, nail-laminated posts – posts with preservative-treated wood on one end and untreated wood on the other end. Questions about the bending strength of various spliced post designs led David Bohnhoff to develop a special finite element modeling method for the posts (Bohnhoff et al., 1989) and to conduct numerous tests on both spliced and unspliced posts (Bohnhoff et al., 1991, Williams et al., 1994, Bohnhoff et al., 1997). This ultimately led Bohnhoff to draft ASAE EP599 *Design Requirements and Bending Properties for Mechanically Laminated Columns* which was approved by ASABE in December 1996, and as an American National Standard by ANSI the following February. In 2009, Bohnhoff chaired a major revision of the engineering practice which included a name change to *Design Requirements and Bending Properties for Mechanically Laminated Wood Assemblies*.

1.4.15 Foundation Design Standard

In the late 1980's, Gerald Riskowski and William Friday (1991a, 1991b) developed equations for calculating the embedment depth of collared post foundations. These equations became part of ASAE EP486 *Shallow Post Foundation Design* which was developed under the direction of Friday and released by ASABE in March 1991. Based on research by Neil Meador, the standard was slightly revised in 1999 and approved as an American National Standard by ANSI in October 2000. In 2007, David Bohnhoff began working on a major

revision to ASAE EP486. Approved in 2012, the revision contains completely different methods for calculating bearing, lateral, and uplift strengths of both pier and post foundations, and unlike previous versions, it contains safety factors for allowable stress design (ASD) and resistance factors for load and resistance factor design (LRFD). Additionally, the revised EP contains several methods for obtaining soil properties from on-site soil tests.

1.4.16 Screw Fasteners

Prior to the 1980's, metal wall and roof cladding was largely nail-fastened. By the late 1980's, many post-frame builders had made the switch from nails to self-piercing and/or self-drilling screws. In some cases, the adoption of screws was tied to the early adoption of diaphragm design. While some companies still used nails for metal cladding attachment in the 1990's, such usage was pretty much curtailed by the turn of the century.

1.4.17 ASAE EP558 Formation

In 1998, provisions in ASAE EP484 covering diaphragm panel tests were removed and placed in a separate publication titled ASAE EP558 *Load Tests for Metal-Clad Wood-Frame Diaphragms*. At the same time, ASAE EP484 was modified to include additional analysis options, and in August 1998 it was approved by ANSI as an American National Standard.

1.4.18 Construction Tolerances

In 1999, NFBA published the first of two post-frame construction tolerances documents. Like tolerance documents developed by other organizations, the NFBA documents were developed to (1) establish standards of professional conduct for members of the organization (2) enhance the professional reputation of the industry, (3) minimize costly litigation between owners and builders, and (4) maintain regulatory control within the profession. The first of these two documents, titled *Accepted Practice for Post-Frame Building Construction: Framing Tolerances*, includes recommended tolerances for the position/placement of footings, posts, trusses, girders, girts, and purlins. This document was drafted by David Bohnhoff and based on research by Marshall Begel (Bohnhoff and Begel, 2000). The second document, titled *Accepted Practices for Post-Frame Building Construction: Metal Panel and Trim Installation Tolerances*, was released by NFBA in 2005 and covers recommended tolerances for metal panel positioning, metal trim positioning, fastener installation, and surface and edge blemishes. This document was also drafted by Bohnhoff but based on research conducted by David Cockrum (Bohnhoff and Cockrum, 2004).

1.4.19 Glulam Posts

There was a steady increase in glulam post use throughout the 1990's, largely spurred by the launching of several companies fully dedicated to glulam post production for post-frame buildings.

1.4.20 Laminated Veneer Lumber

The development and production of laminated veneer lumber (LVL) in the 1980's resulted in a significant increase throughout the 1990's of buildings with solid-web primary frames featuring LVL rafters. Although solid-web primary frames typically cost more than open-web primary frames, they are preferred because of their cleaner appearance, elimination of bird perch points, and greater durability in corrosive environments (i.e., environments that significantly shorten the life of metal connector plates).

1.4.21 CCA Restrictions

Effective December 31, 2003 the EPA restricted the use of chromate copper arsenate (CCA) treated wood in a number of applications including all post-frame building components except embedded posts. This resulted in a switch to different waterborne copper-based treatments (e.g., copper azole (CA), ammoniacal copper zinc arsenate (ACZA)) and greater use of plastic composite materials for splash plank, grade girts and base plates. These products and further developments in wood treatment, including micronized copper, are the primary products used in the industry today.

1.4.22 Precast Concrete Piers

The turn of the century brought with it an increased emphasis on sustainable building construction, that is, more affordable and environmentally-friendly construction. One manner in which this is achieved is by increasing the functional life of buildings and building components. With respect to post-frame buildings, this has stimulated interest in use of concrete piers (Bohnhoff, 2006), especially a precast concrete pier system developed and patented by Bob Meyer Jr. and marketed nationally under the tradename Perma-Column.

1.4.23 Expansion of Screw Use

Advances in screw fasteners and associated installation equipment continue to have a pronounced impact on post-frame building design and construction. Specifically, self-drilling screws with a diameter near a quarter inch are now used by some builders to attach trusses to posts and to connect other primary-framing components. Also, since the turn of the century, builders have begun to use deck screws to attach girts and other secondary framing members, and to install temporary bracing.

Chapter 1 – Introduction to Post-Frame Buildings

1.5 Advantages

As noted in Section 1.1.1, a post-frame building system is one of many types of framing/support systems. A designer who is choosing among various framing systems will assess how each framing system positively and/or negatively affects building **F**unctionality, **A**ffordability, **C**omfort, **A**esthetics, **D**urability, **E**nvironmental-friendliness, and **S**afety (i.e. building FACADES). In each of these areas, a post-frame building system has unique advantages as described in the following paragraphs.

1.5.1 Functionality

To provide a functional building, a designer must have the flexibility to easily and inexpensively (1) alter the interior layout of a building without interference from structural supports, (2) select an optimal clear height and/or vary building clear height, (3) locate exterior doors and windows of any size where they are needed, and (4) apply any combination of horizontal and vertical loads to roof, wall, floor and ceiling elements.

Post-frame building systems provide the aforementioned flexibility by *commonly* and *economically* providing clearspan widths upward of 80 feet and eave heights upward of 20 feet. The relatively large spacing between primary frames enables the installation of large doors and windows at no additional framing cost to the consumer. The ability to easily modify primary frame size and spacing enables designers to easily handle any combination of horizontal and vertical loads.

Indeed, it is the flexibility of the post-frame building system that has resulted in its use in a very broad range of residential, agricultural, commercial and industrial applications. This includes buildings with fully open walls, buildings that are completely sided, and buildings with walls of solid glass or walls comprised entirely of overhead doors. This includes stilt buildings, slab-on-grade buildings, buildings on stem walls, and buildings with full basements. This includes single-story buildings, two-story buildings, structures with high-load capacity lofts and mezzanines, and buildings with stored contents that exert high wall pressure.

1.5.2 Affordability

Significant savings can be obtained with post-frame construction in terms of materials, labor, construction time, equipment and building maintenance. This is directly attributable to the fact that they are among the most efficiently designed structures in the world; and it explains why post-frame buildings dominate markets where cost is the overriding factor in building selection.

When compared to other building systems, the low

relative cost of most post-frame buildings is attributable to the use of less extensive foundations and to the fact that wall sections between posts are non-load bearing. As further explained in Section 1.6.2, embedded post foundations commonly used in post-frame buildings require less concrete, heavy equipment, labor, and construction time than conventional perimeter foundations. Additionally, embedded post foundations are better-suited for wintertime construction - times when frozen ground and cold temperatures increase labor and fabrication costs for other foundation types.

1.5.3 Comfort

Building comfort is largely dictated by thermal envelope design, HVAC systems, and natural lighting. Of these three variables, the only one that is significantly affected by frame selection is thermal envelope design.

One of the outstanding features of post-frame building systems is that they allow for a plethora of thermal envelope designs. This stems from the fact that the space between primary frames can be filled with virtually anything. This includes thermal envelopes that rely on more conventional insulations (fiberglass batts and blankets, rigid polystyrene boards, blown-in-blankets, and foam-in-place insulation products), and extends to infill panels featuring bales of organic fiber, structural insulated panels (SIPs), adobe, cordwood, etc..

1.5.4 Aesthetics

Like most other framing systems, post-frame building systems can be clad with virtually any material and thus can be designed to mirror the appearance of most any structure. Unfortunately, many individuals only see post-frame buildings as simple, rectangular structures with an exterior covering of corrugated steel. This results from the simple fact that such buildings are very inexpensive and thus the building of choice for numerous applications where cost is the overriding factor in design decisions. It comes as no surprise that many post-frame buildings go unrecognized as such by the general public simply because they do not feature corrugated steel siding. These include numerous post-frame buildings with wood siding, brick veneer, stone veneer, and stucco (see figures 1-32 through 1-36).

Building occupancy type typically dictates the type of interior finish. For residential and small business applications, interior walls are typically sheathed with gypsum wall board. For extra appeal, wood posts are frequently left exposed (e.g., not covered with wall board). Additionally, exposed glued-laminated and solid-sawn timbers may be substituted for metal plate connected wood trusses (MPCWT).



Figure 1-32. Post-frame boys and girls club with steel siding and brick veneer. An FBi Buildings project.



Figure 1-33. Wood-clad post-frame building constructed for horse housing.



Figure 1-34. Small commercial post-frame building sided with stucco and brick veneer.



Figure 1-35. Residential post-frame building with brick veneer and fiber-cement board siding.



Figure 1-36. Commercial post-frame building clad in stone and smooth metal panels. An FBi Buildings project.

1.5.5 Durability

Durability is dictated by the degree to which degradation of materials due to decay and corrosion is controlled, and the degree to which load levels are maintained within the design strengths of components and connections. The former is managed by using materials that are compatible with the environment(s) to which they are exposed; the latter is controlled with proper structural engineering.

Durability has been a hallmark of post-frame buildings, as is evidenced by the number of post-frame buildings that are still in use years after exceeding their original design life. This can be attributed to proper use of preservative lumber treatments (or concrete where such treatments are not desired), corrosion resistant fasteners, and wood adhesives.

1.5.6 Environmental-Friendliness

The low cost of post-frame buildings is directly attributable to its efficient use of materials, and hence its very low embodied energy relative to structures of similar size. Much of this is attributable to the reduced use of concrete in foundations. To this end, as more accurate and complete life cycle analysis/assessment methods are developed and used in selection of building systems, greater use of post-frame building systems is expected.

Given the durability of post-frame buildings, it is not uncommon for them to exceed their functional design life. For this reason, many older post-frame buildings are now used for purposes other than which they were initially designed.

In situations where post-frame buildings have outlived their initial need, it may be advantageous to move or reconfigure the structure. This is relatively easy to accomplish with modern post-frame buildings, as they are largely assembled using mechanical fasteners (i.e., bolts and screws) that can be quickly removed without damage to components. This ability to “recycle” a post-frame building adds to their reputation as one of the world’s most environmentally-friendly structures.

Chapter 1 – Introduction to Post-Frame Buildings

1.5.7 Safety

Outstanding structural performance of post-frame buildings under adverse conditions such as hurricanes is well-documented. Gurfinkel (1981) cites superior performance of post-frame buildings over conventional construction during hurricane Camille in 1969. Harmon et. al (1992) reported that post-frame buildings constructed according to engineered plans generally withstood hurricane Hugo (wind gusts measured at 109 mph). Since post-frame buildings are relatively light weight, seismic forces do not control the design unless significant additional dead loads are applied to the structure (Faherty and Williamson, 1989; Taylor, 1996).

1.6 Ideal Structural Applications

Different structural framing/support systems will have different advantages and disadvantages depending upon the particular application. A post-frame building system is no different than any other structural framing/support system in this regard. In general, a post-frame building system will have inherent advantages where it is advantageous to have wood posts as main, load-bearing, vertical framing elements. Following are thirteen such applications highlighted by Bohnhoff (2008).

1.6.1 Buildings With Numerous and/or Relatively Large Wall Openings

Windows and doors in a post-frame building that are narrower than the post spacing typically do not require structural headers, since roof trusses/rafters in most post-frame buildings bear directly on the posts. Elimination of structural headers enables elimination of trimmer studs (a.k.a. jack studs, shoulder studs) and other special structural members required to support the headers.

Removing headers and their supports not only saves money, but results in an enhanced thermal envelope when framing members are replaced with thermal insulation. Additionally, fewer framing members mean fewer cracks for air infiltration.

In general, any building with large, regularly-spaced door and window openings is an ideal candidate for post-frame. Mini-warehouses and service garages typically have several equally-spaced and equally-sized overhead doors making them ideal candidates for post-frame (figures 1-37 through 1-39). In these buildings, posts are often used to frame both sides of the doors. Post frame is also ideal for retail stores with large glass facades (figure 1-40).



Figure 1-37. The numerous, equally-spaced overhead doors of mini-warehouses make them ideal for post-frame.



Figure 1-38. Post-frame suburban garage.



Figure 1-39. Post frame readily accommodates the overhead doors required for this automobile repair business in Lafayette, Indiana. An FBi Buildings project.



Figure 1-40. Large, equally spaced windows suit post-frame.

1.6.2 Buildings Without Basements

Many buildings without basements are supported on cast-in-place crawlspace walls or frost walls that rest on continuous cast-in-place concrete footings. The construction time and concrete cost associated with these continuous concrete foundation walls and footings is significantly greater than that associated with a post-frame building that utilizes embedded posts or a post-on-concrete pier system as its foundation system (figure 1-41).

The material and labor savings associated with post/pier foundation systems makes them the most environmentally-friendly foundation system in common use today. Additionally, embedded post and precast pier foundations can be easily removed and reused – a feature which adds to their status as a very environmentally-friendly foundation system.



Figure 1-41. Preservative-treated, mechanically-laminated embedded post (left) and mechanically-laminated post attached to a precast concrete pier (right).

Most buildings without basements feature concrete slab-on-grade floors. More frequently today, these slabs contain radiant heating systems. When post/pier foundation systems are used, the interior concrete slab can be placed after the building shell has been erected. This has two major advantages. First, concrete is much more protected during its placement from wind, precipitation in all forms, and temperature extremes. This can translate into fewer unexpected scheduling delays,

less need for costly heat and moisture protection systems, and enhanced concrete surface finish, durability, and strength properties. Second, less preplanning is required for below slab installation of HVAC, plumbing and electrical system components. In fact, no preplanning is required when the interior concrete slab is placed after HVAC, plumbing and electrical system installations have been completed. With respect to utilities, it is also important that insulation must be placed under a slab that contains a radiant heating system, and placement of this insulation requires a very level, properly compacted base – something more easily achieved and maintained in a protected environment.

Some builders may opt to place posts on the thickened edge (i.e., grade beam) of a concrete slab. Such systems generally require more total concrete than systems with concrete pier foundations since the extra concrete required for the grade beams usually exceeds that required to fabricate concrete piers.

1.6.3 Buildings with Tall Exterior Walls

Mechanically- and glue-laminated posts are used in the vast majority of today's post-frame buildings. These posts enable the construction of buildings with relatively large floor-to-ceiling heights at prices much less than they could be fabricated with a comparable wood stud wall.

Laminated posts can be fabricated to any length by splicing shorter pieces of wood together. Laminated posts are also straight and inherently more stable because of the laminating process. The only way to get a tall, relatively straight wall with wood studs is to use more expensive, engineered lumber products (e.g., laminated strand lumber, laminated veneer lumber, parallel strand lumber).

The increased bending moments associated with taller walls may be handled by using higher grade lumber or with larger vertical wall framing elements. Another option is to reduce the spacing of the framing elements so that each element is subjected to less load. These options are easy to accommodate into post-frame building design, which is one more reason why they get the nod over other framing systems in tall wall applications such as that shown in figure 1-42.

The cost advantage that post-frame buildings hold over low-rise steel frame buildings generally starts to disappear once minimum floor-to-ceiling heights move beyond 20 feet. Below these heights, post-frame holds thermal insulation advantages, if not cost advantages, over steel frame structures. This has made post-frame very popular for storage facilities such as the airplane hanger in figure 1-43.

Chapter 1 – Introduction to Post-Frame Buildings



Figure 1-42. Post-frame concrete batch plant with a 45 ft ceiling height, accomplished in part by bracing wood columns back to the main structure of the concrete plant equipment.



Figure 1-43. The ability to construct inexpensive buildings with relatively high eave heights makes post-frame ideal for many machinery storage buildings including this airplane hanger.

Required length of vertical wall framing elements are often significantly different in various locations within a building. Where such length variations occur, structural requirements for the longer elements generally control framing/support system selection. Significant wall framing length variations most commonly occur in the endwall framing of wide buildings with sloped ceilings (the dairy freestall barn in figure 1-44 is one such example). Not surprisingly, the endwalls in many of these buildings are post-frame.



Figure 1-44. This building is typical of many dairy freestall barns. The greater width of these buildings results in (1) tall gable endwalls requiring substantial framing, and (2) the need for interior support posts.

1.6.4 Bulk Storage Buildings

Bulk storage refers to the storage of a relatively large quantity of a material or commodity such as cement, sand, salt (figure 1-45), fertilizer, fruit, vegetable, seed, feed, cotton, straw, and aggregate. If a bulk storage building wall is used to contain the stored material, that wall must be designed to resist the resulting horizontal pressure which is directly dependent on the height of the stored material. Even for stored material heights of only a few feet, this pressure will be several times greater than the environmental design pressure applied to exterior walls by even the highest of winds.

As noted in the previous section, high wall forces are easily accommodated in post-frame building design by altering post size and/or spacing. Post spacing is generally dictated by the spanning capability of the structural material used to contain the bulk material.



Figure 1-45. High wall pressures and resistance of wood to corrosion make post-frame the perfect application for salt storage facilities.

1.6.5 Buildings with Open Walls

Buildings whose only purpose is to provide protection from precipitation and/or solar radiation are generally fabricated with one or more open sides. This would include many commodity (e.g. fertilizer, lumber, feed) storage buildings, animal shelters, and park and other recreational shelters (see figures 1-46 to 1-49). Open sides facilitate quick building access, which can translate into significant cost savings when handling stored materials.

Unless a unique structural support system has been employed, expect the roof above an open wall to be supported by posts with an on-center spacing of 8 or more feet. Since these posts are seldom laterally supported between their base and crown, they must be designed to resist buckling equally in all horizontal directions. For this reason they tend to be round poles, square solid-sawn timbers, or square glulam or parallel-strand lumber members. Nail-laminated posts will typically require the addition of face plates to obtain approximately equal bending strength in all horizontal directions.

Wood posts in open-front buildings are often preservative-treated because of their direct exposure to “the elements.” However, in situations where wood posts are supported on concrete piers, or walls are fairly well protected from precipitation with a roof overhang, preservative treatment may be unnecessary.



Figure 1-46. The desire for open sidewalls makes the post-frame building system a popular choice for park and other recreational shelters.



Figure 1-47. Heifer growing facility with open sidewalls.



Figure 1-48. Open front equipment storage building.



Figure 1-49. Hay storage facility with all-around access by. Post spacing on back endwall twice that on front endwall to accommodate machinery access.

1.6.6 Buildings Requiring Interior Posts

When a building has interior columns, it is advantageous to use a post-frame building system for two reasons. First, it increases the likelihood that all building support elements will be on similar footings. This speeds construction and minimizes the likelihood of differential settlement. Second, interior posts may be more effectively incorporated into the framing system since they can be aligned with, and then connected via rafters or header beams to exterior posts to form rugged primary building frames (see figures 1-5 through 1-9).

Interior posts are used in place of interior load-bearing walls, primary because they provide for a more open floor plan. Money may also be saved by switching from bearing walls to posts, since posts utilize isolated footings which require less concrete than the continuous footings used to support bearing walls.

Chapter 1 – Introduction to Post-Frame Buildings

Interior posts are either used to support roofs in wide buildings (figure 1-44) or mezzanines (figure 1-50). In practice, wood-framed roofs that clearspan more than 90 feet and that are subjected to heavy snow loads will generally not be economically competitive with steel roof framing unless interior support is provided.



Figure 1-50. Supporting mezzanines with posts instead of walls provide for more open floor plans.

Interior posts are seldom laterally supported between their base and crown, and thus are designed similarly to posts in open exterior walls.

1.6.6.1 Buildings with Clerestories

A clerestory (a.k.a. clearstory) is a fenestrated (windowed) wall that rises above a roofline (figures 1-51 and 1-52). Because clerestories are used to brighten a building's interior, it is advantageous to support a clerestory wall (and the above roof) with interior posts (and not solid walls).

Clerestories are commonly located above sloping roofs such that the height of the clerestory plus the height of the adjacent sloping roof is roughly equivalent to a single story. Roof slopes associated with clerestories are the same roof slopes common to the typical post-frame building. This combined with the fact that clerestories rely heavily on interior posts explains why buildings with clerestories are commonly post-framed.



Figure 1-51. A clerestory is a common feature on many equestrian facilities.



Figure 1-52. Commercial building (top) and milking center (bottom) with clerestories.

In many cases, the interior posts not only support the walls and roofs of the clerestory, but they also support a second floor level (i.e., a mezzanine or loft) as shown in figure 1-53. In livestock housing facilities, this second floor is commonly used for hay storage.

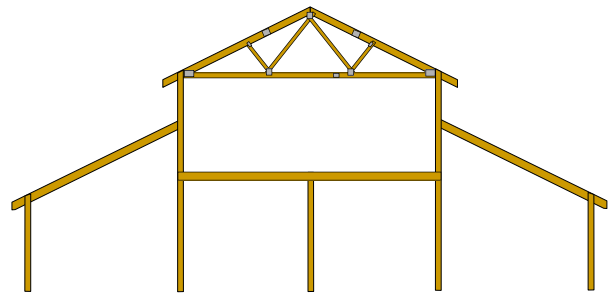

Figure 1-53. Primary frame of a building with clerestory.

1.6.7 Buildings with Large, Clearspan Wood Trusses With On-Center Spacing 4 Feet or Greater

Component connections are critical to the structural integrity of a framing system. In buildings with large, clearspan wood trusses, the most critical connections are those between the truss and its supports. In addition to gravity-induced forces (a.k.a. bearing loads), these connections must resist shear forces acting perpendicular to the plane of the truss and uplift forces due to wind. Depending upon overall building design, the connections may also be required to transfer bending moment.



Figure 1-54. Truss resting on outer ply of a laminated post. Steel L-bracket placed on outer face of truss to help reinforce post-to-truss connection.



Figure 1-55. When truss is sandwiched between outer plies of a mechlam post, bolts are placed in double-shear for a very effective connection.

Wood posts enable the fabrication of strong, direct, yet inexpensive connections between large trusses and walls. Exact details for post-to-truss connections vary from designer to designer, and may be influenced by post type. Solid-sawn timber and glulam posts are generally

notched to form a truss bearing surface. The truss rests on the notches and is bolted into place. A special plate/bracket like that shown in figure 1-54 may be added to increase connection load transfer capabilities. With mechanically-laminated posts, the truss may rest on a shortened outer-ply or on a shortened inner-ply. The latter scenario, which is shown in figure 1-55, places the bolts in double shear and is a very effective connection.

1.6.8 Buildings Requiring a More Open Structural Frame to Accommodate Non-Structural “Infill” Panels/Materials

Post-frame is the ideal structural support system for straw bale walls (figure 1-56), cordwood or stackwood walls (figure 1-57, light-clay coated organic fiber walls and even earthen walls. Given that straw, cordwood, clay-coated organic fibers and earth are all considered very environmentally-friendly materials, expect the number of post-frame buildings that are constructed with in-fill walls of these materials to grow.



Figure 1-56. Non-structural straw bale walls prior to plastering. Image from the American Society of Agricultural and Biological Engineers. Used with permission.



Figure 1-57. Cordwood (a.k.a. stackwood) infill walls.

For frame openness, the post-frame building system is often a more structurally efficient version of a timber-

Chapter 1 – Introduction to Post-Frame Buildings

frame building system. In short, any wall cladding or infill material that has been utilized on or in a timber-frame building may be used on or in a post-frame building. This includes application of structural insulated panels (SIP) to wall and roof surfaces.

1.6.9 Stilt Buildings

Stilt buildings are one of the least expensive options when building in floodplains, over very poor soils or water, on very steep terrain, and in regions of high snow fall (see figures 1-58 to 1-62).

Stilt buildings fall into two categories: those with stilts that only support sill plates and floor headers, and those with stilts that connect to both roof and floor framing. The latter are essentially post-frame buildings with wood-framed floors. Exactly how a post-frame stilt building would be detailed depends largely on desired floor, wall and ceiling finishes as they control the spacing of structural frame components.



Figure 1-58. Deer stand on stilts in Randall, Minnesota.



Figure 1-59. Cabin on stilts in the Missouri Ozarks from <http://www.regionslandcompany.com/>



Figure 1-60. Sound engineering and construction of this post-frame stilt building on Dauphin Island, Alabama saved it from meeting the same fate as the one deposited in its front yard by Hurricane Katrina. FEMA photo.



Figure 1-61. Stilt Houses in the Amazon Basin from http://gallery.nen.gov.uk/asset75336_1615-.html



Figure 1-62. Stilt building on Assateague Island National Seashore.

1.6.10 Towers and Buildings with Towers

Towers are a natural fit for post frame. When post-frame systems are properly connected and anchored, very strong and relatively inexpensive three-dimensional tower frames may be built, as evidenced by the many pole- and post-supported forest fire lookout towers built in North America during the early 1900's (see figure 1-63).



Figure 1-63. Forest fire lookout towers are great examples of how post-frame construction can be used to frame towers. Shown here is the Granite Mountain Lookout, Alpine Lakes Wilderness Area, Washington.



Figure 1-64. Lookout for observing nature, hunting and outdoor recreation. Stands 30 ft. from ground to floor, and 41 ft. to the peak of the roof. The building features 44-ft. long foundation-grade treated four-ply laminated columns on 4 ft. deep embedded footings.

Multi-story towers are becoming popular additions to commercial buildings. In addition to adding flare to a building, they frequently serve as stairwells, sources of natural light, clock towers and observatories. Figure 1-65 shows wood-framed towers and buildings with attached towers.



Figure 1-65. Tower applications are ideal for post-frame. An FBI Buildings project.

Chapter 1 – Introduction to Post-Frame Buildings

1.6.11 Buildings with Post-Supported Porches, Balconies, and Roof Overhangs

The spacing of posts used to support a building's porch, balcony, and/or roof overhang is generally in the 6 to 10 foot range regardless of the building's structural framing/support system. Given that this spacing is typical of the post spacing in most post-frame buildings, there are benefits to using a post-frame building system anytime a building features a relatively long post-supported porch, roof overhang or balcony. First, it increases the likelihood that all building support elements will be on similar footings. This speeds construction and minimizes the likelihood of differential settlement. Second, posts used to support a porch, roof overhang or balcony may be aligned with rafters and then connected via the rafters to posts in the exterior wall to form a more efficient structural frame. See figures 1-66 to 1-73.



Figure 1-66. Post-frame convenience store for Byrne Dairy in Galeville, NY. The storefront features a porch and above balcony. A porch formed by a roof overhang extends along the side of the structure.



Figure 1-67. Post-frame storage/workshop with side porch.



Figure 1-68. Post-frame horse barn with post-supported roof overhang.



Figure 1-69. Post-frame horse barn with arcade.



Figure 1-70. Three views of a post-frame garage with side porch and covered end entrance.

Figure 1-72. Wrap-around porches on a park shelter (top), institutional building (middle) and equestrian facility (bottom).



Figure 1-71. Post-frame motel with wrap-around balcony.

Figure 1-73. Suburban garage with a side porch.

Chapter 1 – Introduction to Post-Frame Buildings

1.6.12 Buildings with Bracket-Supported Overhangs

Roof overhangs and eyebrow overhangs are commonly added to buildings to improve building aesthetics and durability. They improve durability by protecting door and window openings and siding from precipitation. They also keep snow slides away from the building and limit intrusion of direct solar radiation during warm periods.

As the distance that an overhang extends from the building wall increases, it is more likely the overhang will be supported by a post (figure 1-68) or wall support bracket (figures 1-74 to 1-76). Whether post supports or wall support brackets are used is largely dependent on overhang height. Normally, post supports are used for lower overhangs because of headroom clearance issues when wall support brackets are used.

With higher overhangs, wall support brackets generally look better than posts and are normally less expensive than post supports because of the added foundation and header beams required with post supports.



Figure 1-74. Wall support brackets used to support an eyebrow overhang.

Wall support brackets are the ideal overhang support system for post-frame buildings in which truss and post spacing are equal. In such buildings, posts and trusses form a series of post-frames as previously described. When wall support brackets are attached to the posts and framing of the overhang, they add rigidity to each post-

frame. In situations where the overhang is a roof overhang, the wall support bracket attaches the end of the truss to the post, thus functioning much like an exterior knee brace.



Figure 1-75. Wall support brackets used to support a roof overhang.



Figure 1-76. Tall walls, large regularly-spaced windows and wall brackets make buildings similar to this good candidates for post-frame.

1.6.13 Buildings with Corrosive Contents

With few exceptions, metals are unstable and will corrode in ordinary aqueous environments. The rate of this corrosion depends on the hydrogen-ion concentration (pH) of the solution, the specific nature and concentration of other ions in solution, temperature, and other factors. In general, the more humid an interior building environment, the more likely and frequently

moisture will condense on metal surfaces within the building, and the greater will be the rate of metal corrosion. Also, the greater the concentration within a building of acidic gases (e.g., hydrogen sulfide, sulfur oxides, nitrogen oxides, chlorine, hydrogen fluoride), caustic gases (e.g., ammonia), and oxidizing gases (e.g., ozone, nitric acid), the greater will be the rate of metal corrosion within the structure.

Given the higher humidities in livestock housing facilities, and ammonia and hydrogen sulfide gases associated with deposition and decomposition of animal wastes, it is wise to limit direct exposure of metals in such facilities. It is also wise to limit direct exposure of metals in water treatment facilities where chlorine is used, and in facilities where bulk fertilizer, salt (figure 1-45) and other corrosive materials are stored. This is accomplished by using wood-framed structures in which mechanical connectors are hidden or specially coated to reduce corrosion and thus enhance overall durability.

1.7 References

1.7.1 Non-Normative References

- Anderson, G. A., Bundy, D. S., & Meador, N. F. (1989). The force distribution method: Procedure and application to the analysis of buildings with diaphragm action. *Transactions of the ASAE*, 32(5):1791-1796.
- Bohnhoff, D. R. (1992a). Expanding diaphragm analysis for post-frame buildings. *Applied Engineering in Agriculture*, 8(4):509-517.
- Bohnhoff, D. R. (1992b). Estimating frame stiffness and eave loads for diaphragm analysis of post-frame buildings. *Transactions of the ASAE*, 35(3):1043-1054.
- Bohnhoff, D. R. (2006). Concrete piers: Making post-frame buildings greener. *Frame Building News*, 18(1):57-63.
- Bohnhoff, D. R. (2008). Twelve structural applications ideal for post-frame. *Frame Building News*, 20(3):34-43.
- Bohnhoff, D. R. & Begel, M. E. (2000). Accuracy of post-frame building construction. *Applied Engineering in Agriculture*, 16(1):83-88.
- Bohnhoff, D. R. & Cockrum, D. K. (2004). Quality assessment of light-gauge metal cladding and trim installation. ASAE Paper No. 044113. ASAE, St Joseph, MI.
- Bohnhoff, D. R., S.M. Cramer, R. C. Moody, C. O. Cramer. 1989. Modeling Vertically, Mechanically Laminated Lumber. *Journal of Structural Engineering*, ASCE, 115(10):2661-2679.
- Bohnhoff, D. R., Chiou, W.S., & Hernandez, R. (1997). Load-sharing in nail-laminated assemblies subjected to bending loads. ASAE Paper No. 974090. ASAE, St Joseph, MI.
- Bohnhoff, D. R., Moody, R. C., Verrill, S. P., & Shirek, L. F. (1991). Bending properties of reinforced and unreinforced spliced nail-laminated posts. Res. Pap. FPL-RP-503. U.S. Department of Agriculture, Forest Service, Forest Products Laboratory, Madison, WI.
- Bryan, E. R. (1973). *The stressed skin design of steel buildings*. Crosby Lockwood Staples, London.
- Bryan, E.R. & El-Dakhkhni, W.M. (1968). Shear flexibility and strength of corrugated decks. *ASCE Journal of the Structural Division*, 14(ST11):2549-2580.
- Davies, J. M. (1977). Simplified diaphragm analysis. *Journal of the Structural Division*, 103(ST11):2093-2109.
- Davies, J. M. & Bryan, E. R. (1982). *Manual of stressed skin diaphragm design*. John Wiley & Sons, Inc., New York, NY.
- Faherty, K. F. & Williamson, T.G. (1989). *Wood engineering and construction handbook*. McGraw-Hill Publishing Company, New York, NY.
- Gebremedhin, K. G., Bahler, E. L., & Humphreys, S. R. (1986). A modified approach to post-frame design using diaphragm theory. *Transactions of the ASAE*, 29(5): 1364-1372.
- Gurfinkel, G. (1981). *Wood engineering*. (2nd Ed.). Kendall/Hunt Publishing Company, Dubuque, Iowa.
- Harmon, J. D., Grandle, G. R. & Barth, C.L. (1992). Effects of hurricane Hugo on agricultural structures. *Applied Engineering in Agriculture*, 8(1):93-96.
- Hausmann, C. T. & Esmay, M. L. (1977). The diaphragm strength of pole buildings. *Transactions of the ASAE*, 20(1):114-116.
- Hoagland, R. C. & Bundy, D. S. (1983). Post-frame design using diaphragm theory. *Transactions of the ASAE*, 26(5):1499-1503.
- Hurst, H. T. & Mason Jr., P. H. (1961). Rigidity of end walls and cladding on pole buildings. *Journal of the ASAE*, 42(4):188-191.
- Johnston, R. A. & Curtis, J. O. (1984). Experimental verification of stress skin design of pole-frame buildings. *Transactions of the ASAE*, 27(1):159-164.
- Kelso, W. (2011). James fort: lost and found. *Colonial Williamsburg Journal (Journal of the Colonial Williamsburg Foundation)*, 33(2)

Chapter 1 – Introduction to Post-Frame Buildings

Knight, J.T. (1989). A brief look back. *Frame Building Professional*, 1(1):38-43.

Luttrell, L. D. (1967). Strength and behavior of light-gage steel shear diaphragms. Cornell Engineering Research Bulletin 67-1. Ithaca, NY.

Manbeck, H. B. (1990). Engineering practice for post-frame diaphragm design. *Frame Building Professional*, 1(5):5, 22-24.

Meador, N. F. (1996). Mathematical models for lateral resistance of post foundations. *Transactions of the ASAE*, 40(1):191-201.

Norum, W.A. (1967). Pole buildings go modern. Journal of the Structural Division, ASCE, Vol. 93, No.ST2, Proc. Paper 5169, April, pp.47-56.

Riskowski, G. L. & Friday, W. H. (1991a). Design equations for collared post foundations. *Transactions of the ASAE*, 34(5):2141–2148.

Riskowski, G. L. & Friday, W. H. (1991b). Post foundation design equations: Validation and sensitivity analysis. *Transactions of the ASAE*, 34(5):2149–2156.

Taylor, S.E. (1996). Earthquake considerations in post-frame building design. *Frame Building News* 8(3):42-49.

Williams, G. D., Bohnhoff, D. R., and Moody, R. C. (1994). Bending properties of four-layer nail-laminated posts. Res. Pap. FPL-RP-528. U.S.D.A. Forest Service. Forest Products Laboratory, Madison, WI

White, R. N. (1978). Diaphragm action of aluminum-clad timber-framed buildings. ASAE Paper 78-4501, ASAE, St. Joseph, MI.

1.7.2 Normative References

ASAE. (1989). ASAE EP484: *Diaphragm design of metal-clad, post-frame, rectangular buildings*.

ASAE. (1998). ANSI/ASAE EP484.2 *Diaphragm design of metal-clad, wood-frame, rectangular buildings*.

ASAE. (1991). ASAE EP486: *Shallow post foundation design*.

ASAE. (1999). ANSI/ASAE EP486.1: *Shallow post foundation design*.

ASABE. (2012). ANSI/ASAE EP486.2: *Shallow post and pier foundation design*.

ASAE. (1998). ASAE EP558: *Load tests for metal-clad wood-frame diaphragms*.

ASAE. (1997). ANSI/ASAE EP559 *Design requirements and bending properties for mechanically laminated columns*.

ASABE. (2010). ANSI/ASAE EP559.2 *Design requirements and bending properties for mechanically-laminated wood assemblies*.

ASABE. (2010). ANSI/ASABE S618: *Post frame building system nomenclature*.

ASCE. (2010). ASCE/SEI 7-10: *Minimum design loads for buildings and other structures*.

AWC. (2012). ANSI/AWC NDS-2012: *ASD/LRFD National design specification for wood construction*.

NFBA. (1999). *Accepted practices for post-frame building construction: Framing tolerances. Version 1*.

NFBA. (2005). *Accepted practices for post-frame building construction: metal panel and trim installation tolerances. Version 1*.

1.8 Acknowledgements

The following companies provided images for this chapter:

CB Structures, 202 Orlan Rd, New Holland, PA 17557. <http://www.cbstructuresinc.com/>

Eversole Builders, 2495 Election House Road, Lancaster, OH 43130. <http://www.eversolebuilders.com/>

FBi Buildings, Inc., 3823 W 1800 S, Remington, IN 47977. <http://www.fbibuildings.com/>

Fingerlakes Construction Company, 10269 Old Route 31 West, Clyde, NY 14433. <http://www.fingerlakesconstruction.com/>

Fuog Interbuild Inc., PO Box 237, Purcellville, VA 20134. <http://www.fuoginterbuildinc.com>

Hochstetler Buildings, Inc., 7927 Memorial Drive, Plain City, OH 43064. <http://www.hochstetler.net/>

Keystone Barn Supply, LLC "Keystone Barns", New Holland, Pennsylvania 17557, <http://www.keystonebarns.com/>

Lester Building Systems, 1111 Second Avenue South, Lester Prairie, MN 55354. <http://www.lesterbuildings.com/>

Meyer Buildings, 444 W 1st Avenue, Dorchester, WI 54425. <http://www.meyerbuildings.com/>

Morton Buildings, Inc., PO Box 399, Morton, IL 61550-0399. <http://mortonbuildings.com/>

MPB Builders, Inc., 654 E. Oshkosh St., Ripon, WI 54971, <http://mpbuilders.com/>

Quality Structures, 167 HWY 59, Richmond, KS 66080. <http://www.qualitystructures.com/>

RAM General Contracting Inc., 592 Industrial Drive,
P.O. Box 660, Winsted, MN 55395.
<http://ramgeneralcontracting.com/>

Wick Buildings, LLC, 405 Walter Road, Mazomanie, WI
53560. <http://www.wickbuildings.com/>

Windler Building Solutions, 2549 Hogan RD, Pacific,
MO 63069. <http://windlers.net/>